

The purpose of this user manual is to help users understand and use the da Vinci Junior 1.0w 3D printer correctly. It contains the operating instructions, maintenance information and application skills of the da Vinci Junior 1.0w 3D printer. To learn more about the latest news of the da Vinci Junior 1.0w 3D printer, please contact local dealers or visit the official website of XYZprinting: <http://www.xyzprinting.com>

## Trademarks

All trademarks and registered trademarks are the property of their respective owners.

## Print History

New editions of this manual incorporate new and changed material different from previous editions. Minor corrections and updates may be incorporated into reprints of the current edition without releasing additional announcements or documentation regarding the updated version. The User Manual is for user reference only. If you need to obtain the latest information, you are welcomed to visit the XYZprinting website: [www.xyzprinting.com](http://www.xyzprinting.com)



- 1 Before using this printer, please first remove the fixed materials from the printing module and printing bed. Switching on the printer's power without removing these fixed materials may damage the machine.

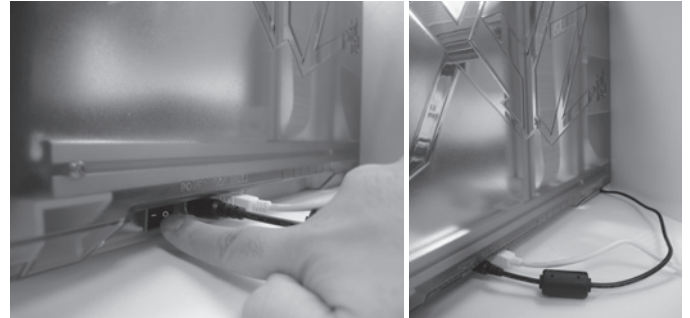

- 2 Before launching XYZware, connect the PC to with printer using the USB cable. For a better user experience, it is strongly advised to follow the proper procedure for using the product.

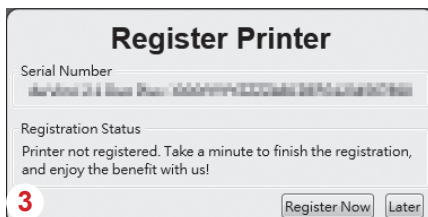

- 3 Registration via XYZware before your first print is strongly recommended. When registered with XYZprinting, you will receive latest technical supports and updates. To register, simply click "Register Now" to begin.

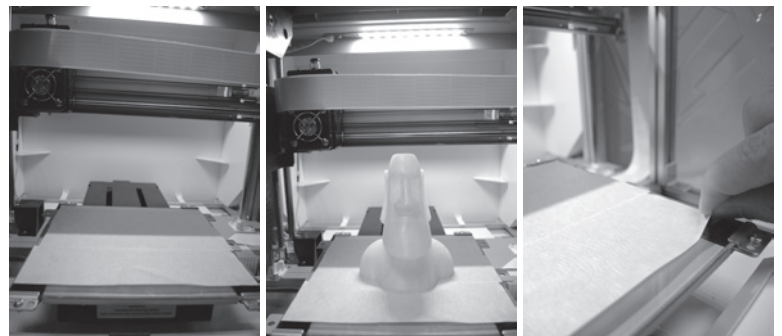

- 4 Before you start printing, please affix the bed tape on the print bed. The bed tape may be removed after printing is complete. (Bed tape can be reused.)

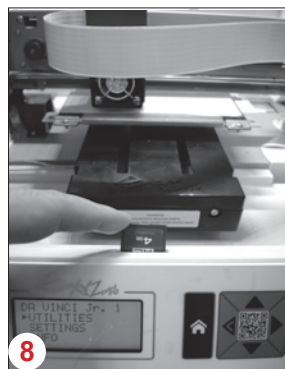

- 5 You may use XYZware to initiate manual updates to the printer firmware and software. When using the printer for the first time, we recommend connecting to the Internet and performing manual update once to obtain the latest resources.
- 6 The optimal room temperature for printing is 15-32 °C (60-90 °F). Printing quality may be affected if room temperature is higher or lower.
- 7 If you need more detailed technical support and program resources, visit the website: [http://support.xyzprinting.com/global\\_en/Support](http://support.xyzprinting.com/global_en/Support)
- 8 Before operating the printer, insert the SD card in the SD card port to make sure that the printing program is able to run properly.

**Please carefully read the contents of the product instruction manual before using this product.**

# Important Notice

## Product Overview

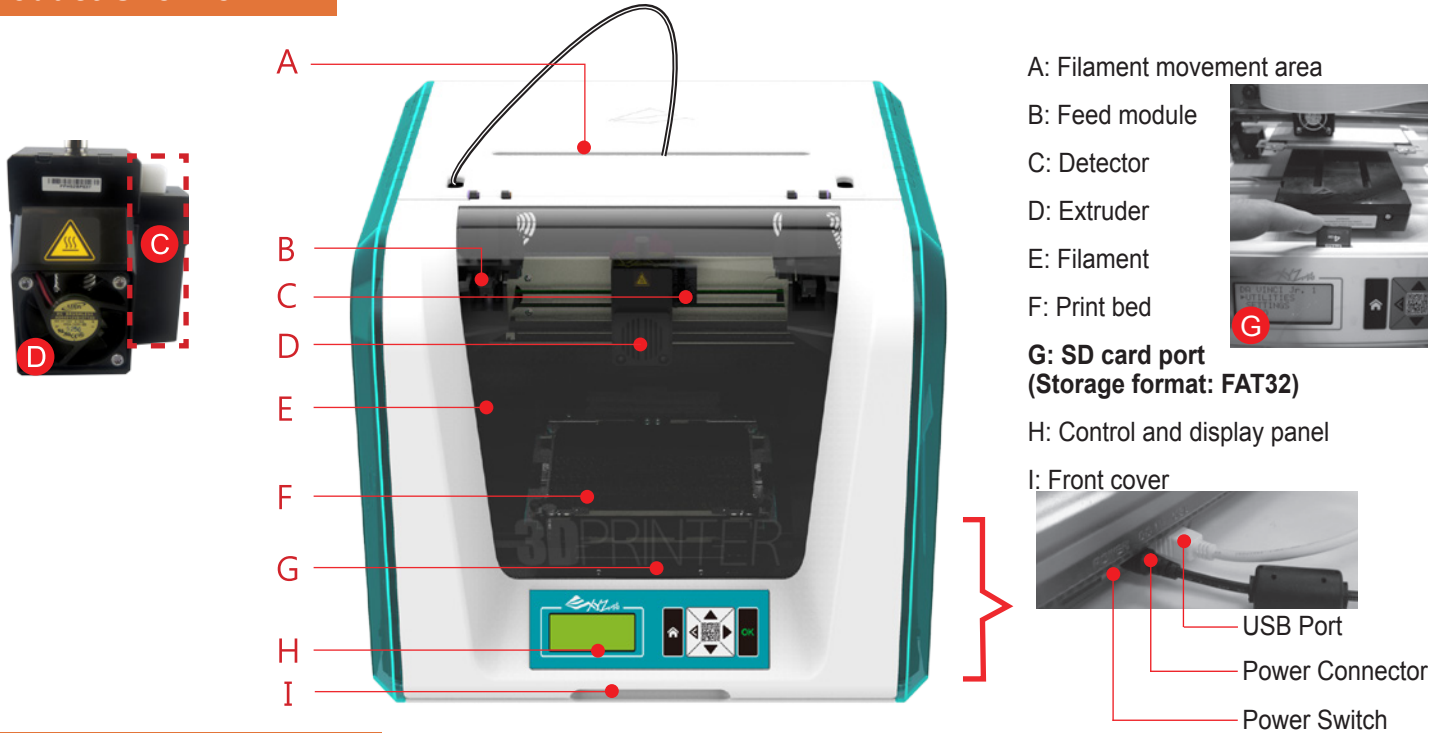

## Accessory Checklist



(For replacing and installing the Feeding Tube Grip, please watch the tutorial video on XYZprinting official website)

## Important Safety Instruction for Use of Maintenance Tools

- The maintenance tools provided should be only handled by an adult. Please keep the tools away from children.
- Store the gear cleaning brush properly. This tool shall only be used to clean the specified parts of the machine and should not be used for the cleaning of other parts to prevent damaging the machine.
- The scraper is used to remove the object from the print bed when printing has finished. The bed tape is reusable and it can be replaced when it has worn out.

## Important Safety Instruction

- Do not place the printer in humid or dusty environment such as bathrooms and high traffic areas.
- Do not place the printer on a rickety surface and/or inclined position. Printer may fall down/or tumble and it may cause serious injury.
- Please keep the front door closed during printing to avoid injury.
- Do not touch the interior of the printer while printing. As it may be hot and include moving parts.

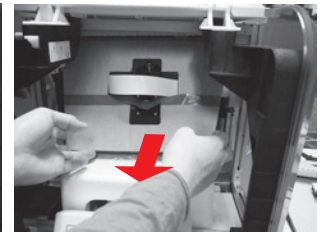
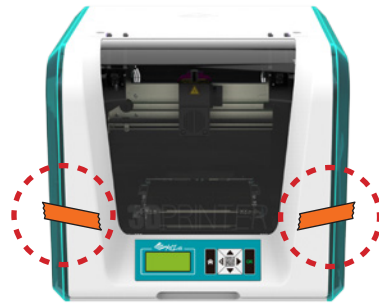
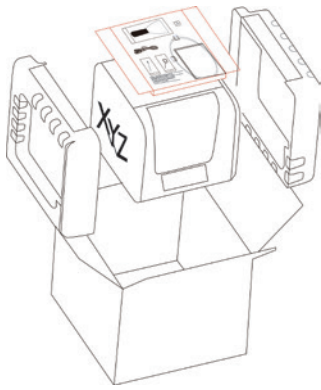

**1** Open the box and remove the accessories and cushions.

**2** Remove the plastic bag and the tapes.

**3** Raise the paper cardboard slightly upwards so that the paper cardboard is detached from the styrofoam slot at the bottom.

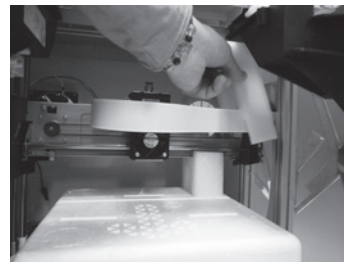
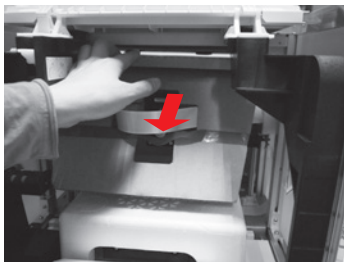

**4** Raise the paper cardboard slightly upwards so that the paper cardboard is detached from the styrofoam slot at the bottom.

**5** Remove 2 foams at the back of the cardboard.

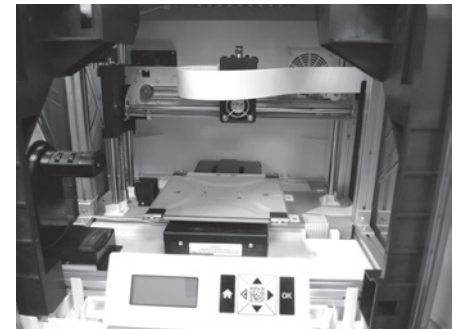
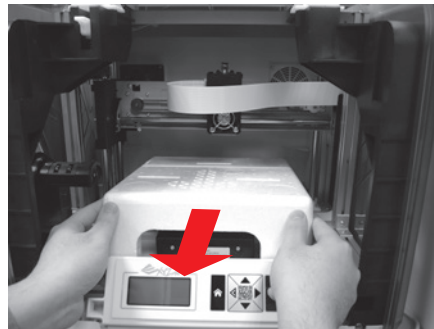
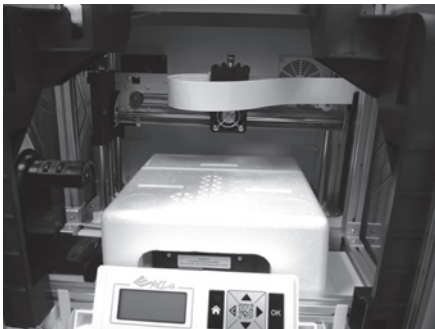

**5** Remove the securing styrofoam next to the print bed.

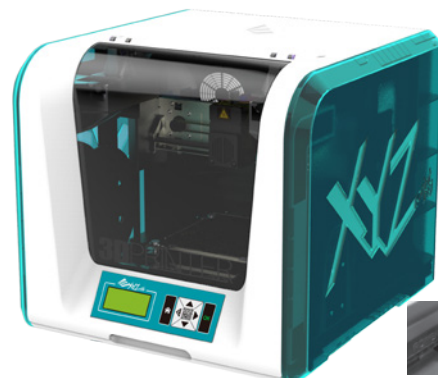

**6** Insert the SD card that came with the printer into your computer or download the latest XYZware from the official Website and install it on the computer.

**7** Use the USB cable to connect the printer to PC. Connect the power cord to the printer then turn on the power switch.

**Note: please use the original power adapter and power cord along with the printer in order to prevent product damage or safety hazards caused by differences in voltage specifications.**

# Unpacking the Product

**⚠ Note: Please follow these steps and ensure that the guide tube is properly installed before starting the "LOAD FILAMENT" function. Failure to install the guide tube may disrupt filament feed.**

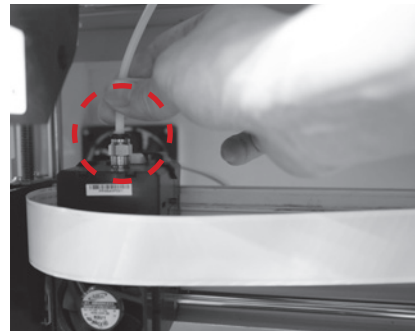
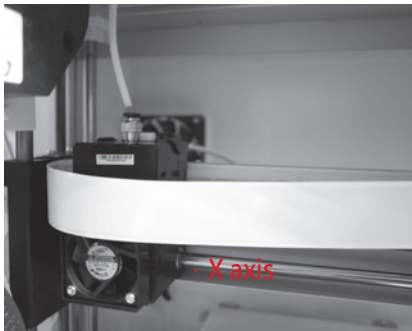
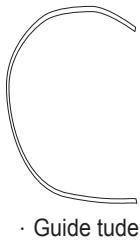

**1** Before installing the guide tube, turn off the printer and move the extruder to the far left-end of the X-axis. If not done otherwise, the print quality will be affected.

**2** After the extruder has been adjusted, insert the guide tube into the extruder.



**3** Direct the guide tube from the tube movement area out of the machine and then insert the other end of the filament tube into the feed module tube port.

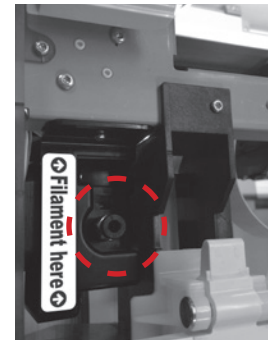
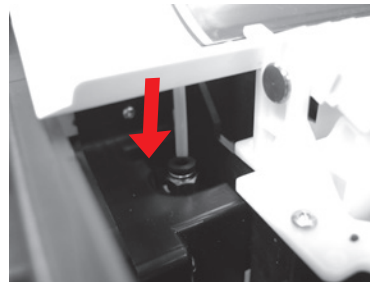

**4** Ensure that the guide tube has been tightly inserted into the port to complete the guide tube installation process.

**↑ Filament here ↑**

**Reminder: If you are not too sure where the feed module tube port is, you may open the casing of the machine to see the indication label.**

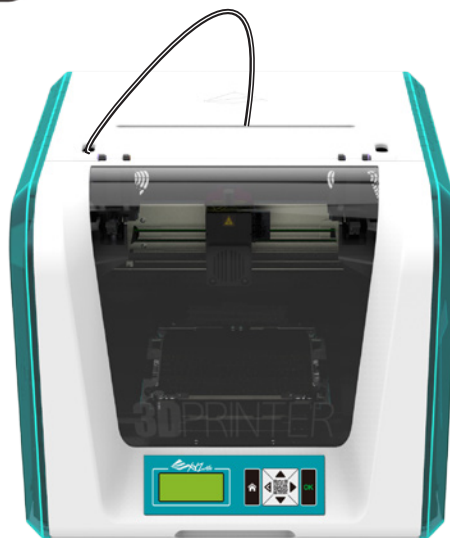

# Installing the Accessories

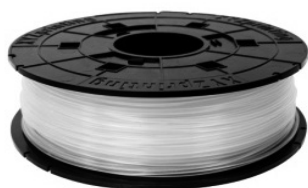
**CHANGE SPOOL**

- 1 First retrieve filament spool to install the filament spool axle ring.

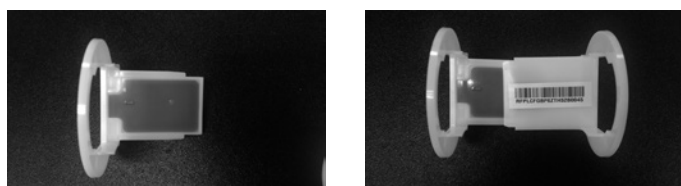

- 3 Install the sensor chip. Please pay special attention to the position of the installation holes on the chip.

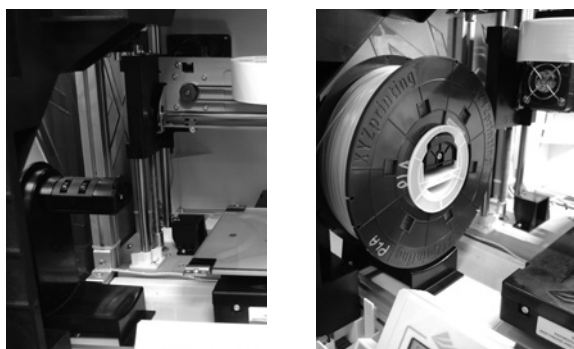

- 5 Place the assembled filament spool (with the spool axle rings) on the filament holder on the left side of the printer.



- 7 Open the release arm and push the filament all the way to the bottom so that the front end of the filament is completely inserted into the feed module.

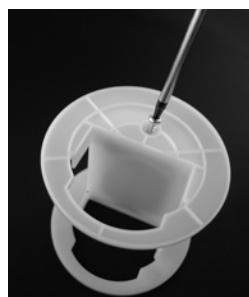

- 2 Take out and separate the filament spool axle ring into its two components.

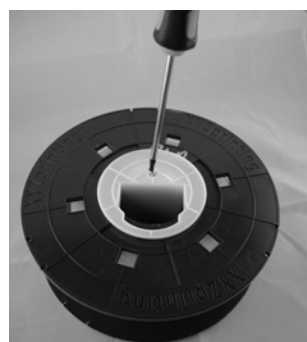

- 4 Insert the filament spool axle ring components to either side of the filament spool, and use a cruciform screwdriver to tighten and secure the rings to the axle to complete the installation of the filament spool axle rings.

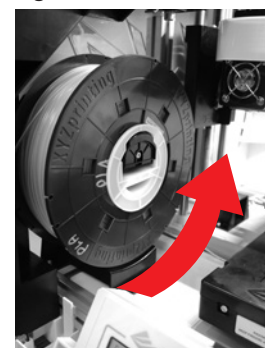

- 6 Pull out a section of the filament and insert it into the feed port.

**Caution:** Pay attention to the direction the filament is being pulled out and ensure that the filament spool axle is being rotated in the correct manner.

## LOAD FILAMENT

Then load filament using the control panel on the printer...

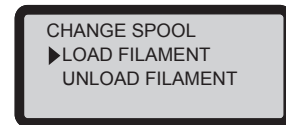
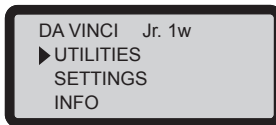

- 1 Select "UTILITIES" > "CHANGE SPOOL" > "LOAD FILAMENT".

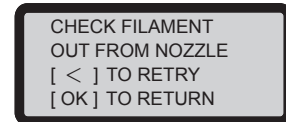
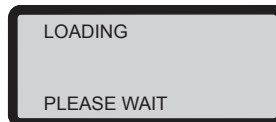
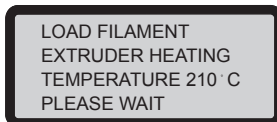

- 2 Wait for the extruder to heat up and load filament.

- 3 Check if the nozzle outputs filament and press "OK" to go back to main menu.

## UNLOAD FILAMENT

First unload filament using the control panel on the printer...

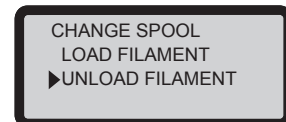
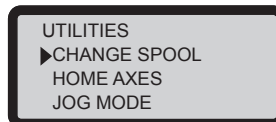
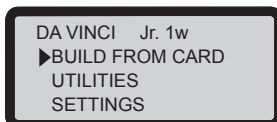

- 1 Select "UTILITIES" > "CHANGE SPOOL" > "UNLOAD FILAMENT".

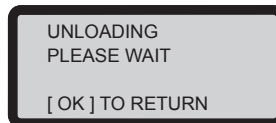
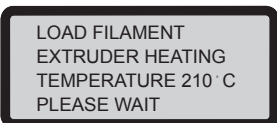

- 2 Wait for the extruder to heat up and unload filament. Press "OK" to pull out filament.

When finishing "UNLOAD FILAMENT"

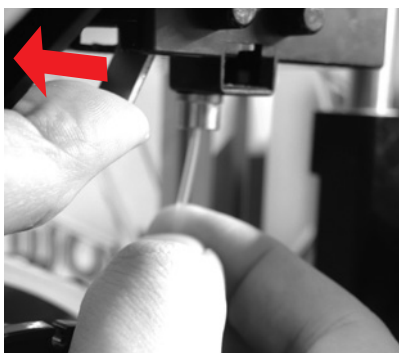

First open the release arm and then pull out the filament with spool axle rings. Arrange it properly for later use.

**Note: Always implement the "UNLOAD FILAMENT" function when replacing the cartridge in order to ensure proper removal of the filament. Cutting filament too closely to the print head may result in residual filament blocking and causing damage to your print head.**

# Unload Filament

The troubleshooting instruction may guide you to fix the problem. If any error persists, please contact customer service. When an error occurs, please refer to the service code shown on the printer and/or in the software, and check the suggestions below for troubleshooting.

#### Technical Support

Website: <http://support.xyzprinting.com>

Email: US - [supportus@xyzprinting.com](mailto:supportus@xyzprinting.com)

EU - [supporteu@xyzprinting.com](mailto:supporteu@xyzprinting.com)

Other regions - [support@xyzprinting.com](mailto:support@xyzprinting.com)

Service Code	Symptom	Action
0 0 0 7	Cartridge 1 chip error	Reinstall the cartridge or change a new cartridge.
0 0 0 8	Cartridge 1 chip error	Reinstall the cartridge or change a new cartridge.
0 0 1 4	Extruder 1 heating problem	Check connections, reboot the printer.
0 0 2 8	Cartridge 1 not installed	Install/reinstall cartridge.
0 0 2 9	Cartridge 1 chip error	Replace cartridge 1 before printing.
0 0 3 0	X-axis movement abnormalities	Check motor/sensor connections.Check sensor position.
0 0 3 1	Y-axis movement abnormalities	Check motor/sensor connections.Check sensor position.
0 0 3 2	Z-axis movement abnormalities	Check motor/sensor connections.Check sensor position.
0 0 5 0	Internal communication error	Reboot the printer.
0 0 5 1	Internal communication error	Reboot the printer.
0 0 5 2	Extruder storage error	Replace the extruder.
0 0 5 7	Unable to detect extruder	Please reinstall the extruder and reconnect the flat cable, then restart the printer.

Error message	Action
The printer is handling other task	Try again after all tasks are completed. Also check the information shown on printer display.
Unable to update printer firmware	Check Internet connectivity / Update firmware again later.
Filament 1 jammed	Unload and reload cartridge 1 and clean the nozzle.
Filament 1 loading problem	Unload and reload cartridge 1.
Filament 1 installation problem	Reinstall the cartridge 1 or change a new cartridge.
Top cover open	Close the top cover.
Filament 1 level low: 30m left	Replace cartridge 1 when necessary.
Filament 1 level low: 5m left	Replace cartridge 1 immediately.

#### Note:

**Please retain all original packaging material when shipping your product for warranty purposes. Shipping without original packaging materials may cause product damaged during the shipment and may cause chargeable service fees.**



## da Vinci Jr.1.0w 3D Printer

Model Name	da Vinci Junior 1.0w 3D Printer
Dimensions	16.54 x 16.93 x 14.96 inches ( 420 x 430 x 380 mm )
Weight	26.46 lbs (12kg)
Display	2.6" FSTN LCM
Language	Multi language
Connection method	USB Wire / SD Card / WiFi
Print Technology	FFF (Fused Filament Fabrication)
Build Volume	5.9 x 5.9 x 5.9 inches ( 15 x15x15cm )
Print resolution	100 - 400 microns
Print module	Single Nozzle
Nozzle diameter	0.4 mm
Filament diameter	1.75 mm
Files supported	.stl , XYZ Format(.3w)
Operating system	Windows 7 - 8 above (for PC) Mac OSX 10.8 64-bit above (for Mac)
Hardware requirement	X86 32/64-bit compatible PCs with 2GB+ DRAM (for PC) X86 64-bit compatible Macs with 2GB+ DRAM (for Mac)

## Environmentally friendly materials-PLA

PLA filaments are made using polymerized lactic acid, which is extracted from corn, sugarcane or other sugar-containing crops, and is regarded as the most environmentally friendly 3D printing material. Unwanted PLA printed objects can be simply discarded in the soil where it will naturally decompose.

PLA materials printed at low temperatures are not only suitable for family settings, its bright texture also makes it a favorite amongst our clients. You may observe the characteristics of PLA during printing.

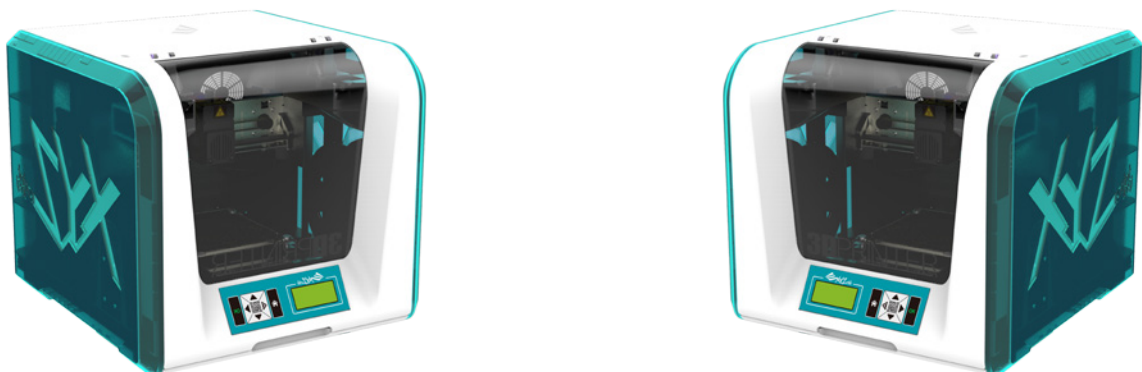

- Despite their harmlessness, PLA placed in an environment or water bath exceeding 50 °C (122 °F) will soften and deform.
- Hence, overly humid areas are not suitable storage environments for PLA. We recommend properly sealing and stashing away unused PLA filaments.
- A sugary smell is often generated when printing with PLA filaments, giving yet another attractive feature.

# Specifications

## About the da Vinci junior series 3D printer

The da Vinci junior series 3D printer (da Vinci Jr.) is a brand new product from XYZprinting that is dedicated to the 3D printer market. Its intricate and colorful exterior as well as its high resolution printing specifications are set to make it the new favorite for families and home hobbyists. Whether you're creating an enjoyable learning playground to inspire your children's creativity or unleashing your innovative ideas and quickly generate prototypes for your products.



## Present creativity

To learn more about presenting your creativity, please visit the Gallery section of XYZprinting's official website.

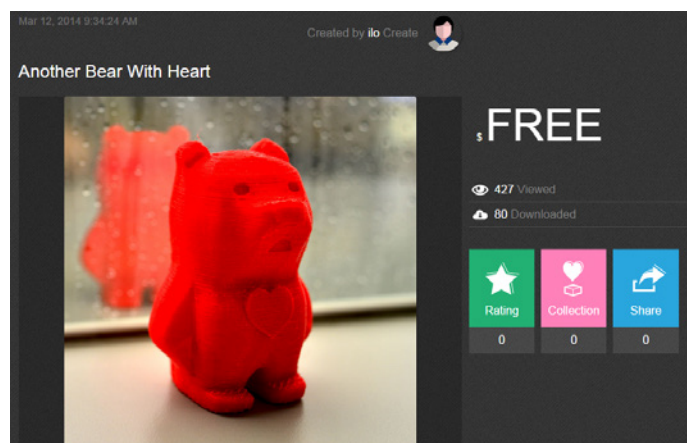







## Product features

- Environmentally friendly 3D printer that satisfies the WEEE recycling requirements, and utilizes the environmentally friendly PLA filaments for printing.
- Satisfies electrical appliance safety specifications of the EU and many other countries, making it the best home-based 3D printer for the entire family.
- Detachable SD card that allows you to store 3D model files that you have created and edited for easy printing. (Please export .stl files into .3w format via XYZware before printing.)
- A gallery of 3D objects is available for download after free registration.
- Amazing power saving design with a maximum power consumption of 75W, offering low power usage even for extended use.
- Weighs only 12 kg, and can be easily integrated in any household and family settings.
- Smart temperature control designs. Cooling fans within the machine is able to adjust and optimize printing temperature to improve product quality.

# Introduction

## Button instructions

After switching on the printer's power, the user may use the display panel at the front of the printer to understand its status and usage data. The functional buttons on the right allow the user to perform the relevant operations.

Button		Functions
Up		Direction Up
Down		Direction Down
Left		Back to previous menu / Reduce the adjustment value
Right		Forward to submenu / Increase the adjustment value
OK		OK; confirm selection/settings
HOME		Home Button, return to main menu



Function	Description
UTILITIES	Printer adjustment / Change filament / Sample printing
SETTINGS	The parameters of printer
INFO	The firmware and printer statistical information
MONITOR MODE	Monitor of extruder and print bed working temperature and printing progress

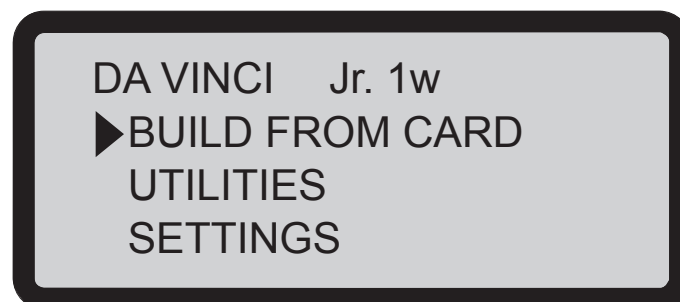

# Functions

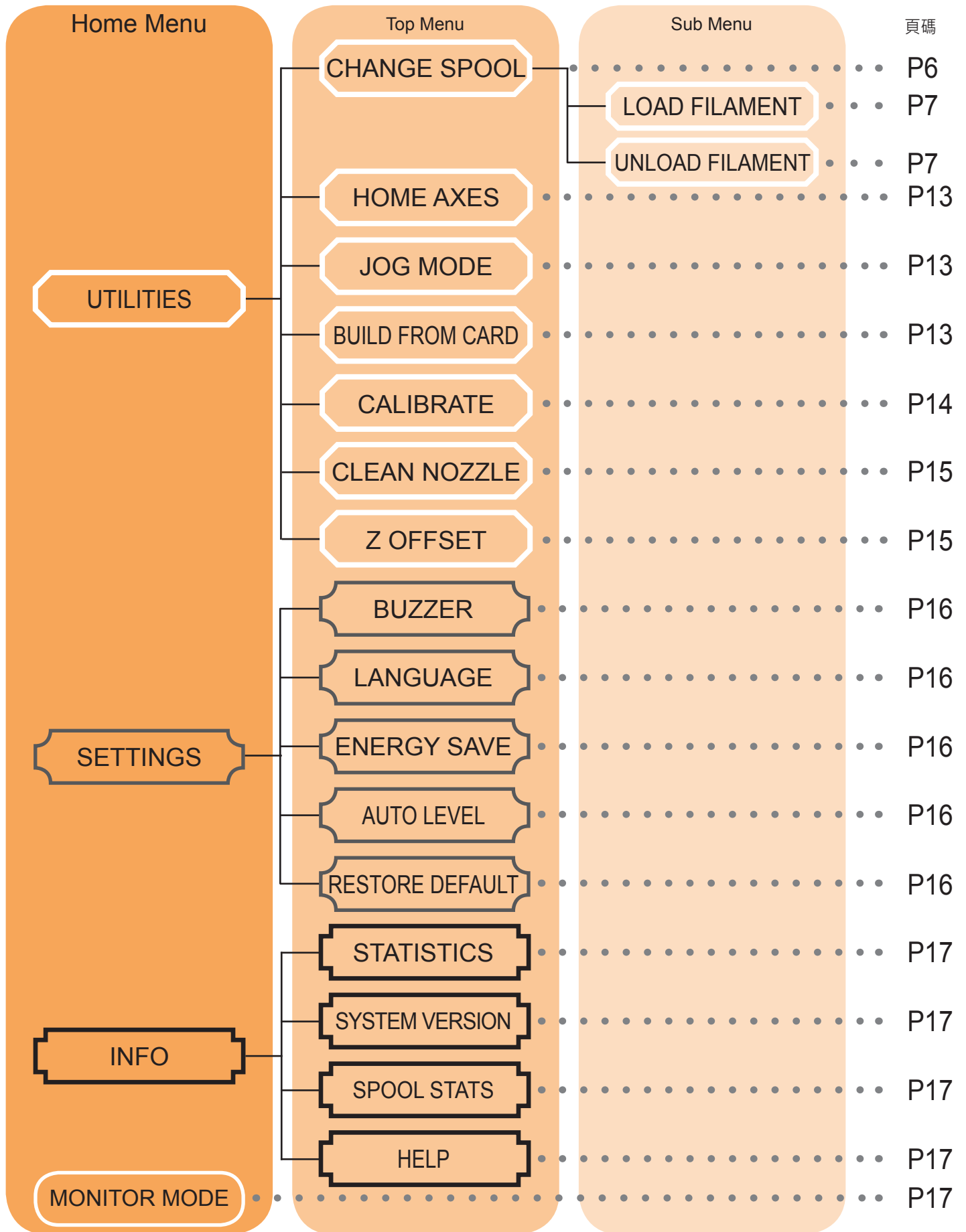

The map above shows the functions your may access with the control panel on the printer. For detailed descriptions of each function, please refer to their respective pages in this user manual.

# Maps of Functions

## HOME AXES

“HOME AXES” moves the extruder to the lower left corner.

To home axes:

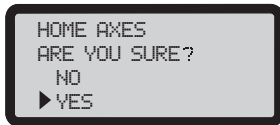

Select “YES” to proceed.

## JOG MODE

“JOG MODE” is used to manually move the extruder and the print bed.

To move the extruder:



1. Select “X-AXIS” (to move right and left) and “Z-AXIS” (to move up and down). Execute “Home Axes” function first to move “Z-AXIS”. “Y-AXIS” (to move print bed backwards and forwards).

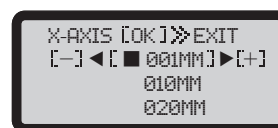

2. Select desired increment of travel with and buttons, and press (or hold) or button for desired direction to move the extruder.

## BUILD FROM CARD

3 sample models are built into the printer. You may begin your first 3D prints with the samples.

To print a sample:

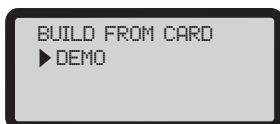

1. Select a sample to print



2. Put the bed tape on the print bed.

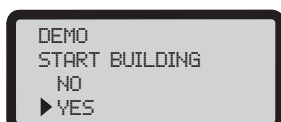

3. Select “YES” to start printing

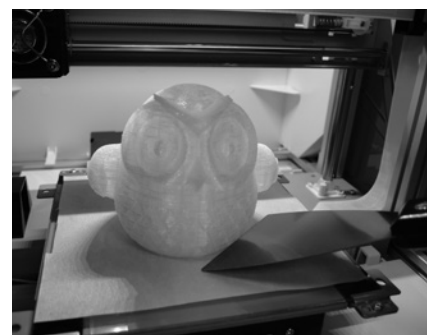

4. Remove the printed object when the printing has finished and the print bed has descended. The bed tape is reusable and it can be replaced when it's worn.

## CALIBRATE

To ensure printing quality, please update printer firmware to the latest version. With latest printer firmware, you may calibrate the print bed in case of low quality printing.

1. Active print bed calibration by selecting "UTILITIES" > "CALIBRATE" > "YES" on the screen.
2. Press the detection head on the right side of the print head according to the instruction of screen message, followed by pressing OK.

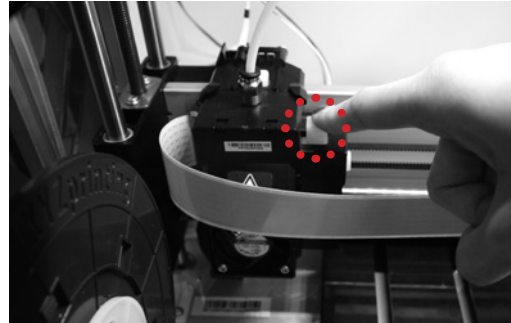
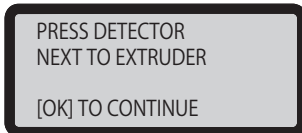

3. Wait for detecting.

4-1A. If "SUCCESS" is shown for the detection result, and "AUTO LEVEL OFF" is shown on the third row on the screen, it indicates good platform levelness. Press "OK" to exit and print.



4-1B. If you see "AUTO LEVEL ON" under "SUCCESS", this indicates that the print bed is slightly unlevelled.

The printer will adjust the configuration based on the detecting result automatically while "AUTO LEVEL" is enabled. The printing mode helps to improve printing quality with slower printing speed. You may switch off the function under "Settings".



4-2. If the detecting result is shown as "FAIL", press "OK" to go to next page, and press "OK" again to exit.

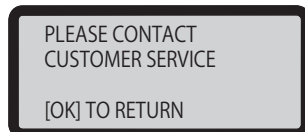

And check the detecting result by going to "INFO" > "LEVELING INFO". Contact customer service for the issue and provide the details of leveling information.



Note:

1. The dirt on the detection head and the top of print module will influence detection result. Make sure that the dirt is cleaned before calibration the platform, and remember to install and locate the print module.
2. If the residues is on the top of the print module, the detection result will be shown as follows. Clean the dirt before recalibration of the platform. Clean the dirt before recalibration of the platform.

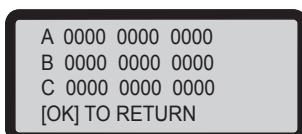

3. The printer may enable or disable auto-level based on the result of calibration. You may switch off the function manually under "Settings".

## CLEAN NOZZLE

Over time, carbon deposits or filament dust buildup in the nozzle may decrease its performance. It is advised to clean the nozzle after every 25 hours of printing.

Also, if the print bed calibration shows "ERR" or if there is any residue on your prints, you may try to clean the nozzle.

To clean the nozzle:

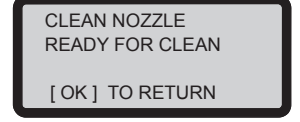
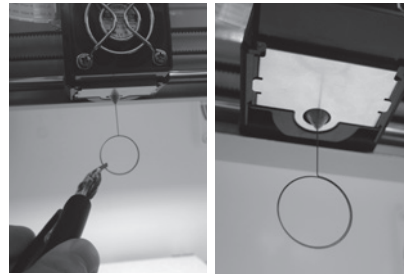
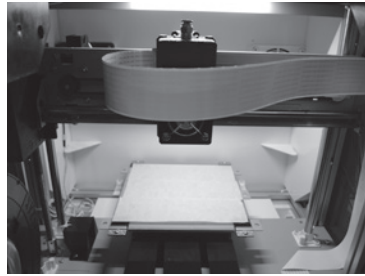
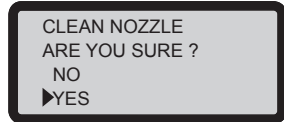

1. Select "YES" to begin.
2. Wait until the extruder heats up and moves to the front, and the screen shows "READY FOR CLEAN"
3. Hold the cleaning wire with the pliers, and carefully pass the wire through the nozzle opening.
4. Select "OK" to return.

If the cleaning cycle does not unplug the extruder, try cleaning the feeding path by following the steps below.

1. Unload filament correctly (refer to "UNLOAD FILAMENT").
2. Move the extruder and the print bed to the home position by using the HOME AXES function.
3. Activate "UNLOAD FILAMENT" again and wait until the extruder is heat up to 150°C. (Care should be taken during the operation to avoid potential burn injuries.)

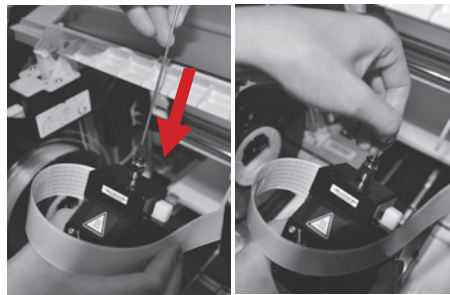
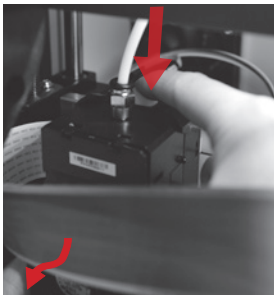

4. Press the white button at the back of the extruder to release it.
5. Lightly press the spring around the feed hole and remove the filament guide tube (do not disconnect the white flat cable)
6. Insert the thick cleaning wire into the feeding path all the way down and "floss" the inside of the nozzle to pull the residue out.
7. After cleaning the feeding path, reinstall the guide tube to the top of the extruder and install the extruder to the bracket.

## Z OFFSET (adjust the printer module)

The user may use the Z OFFSET function to adjust the gap between the printing nozzle and the printing bed.

Caution: This printer has already been tested and adjusted to the optimal gap between the printing nozzle and printing bed before shipping. We recommend recording the original settings before carrying out any adjustments.

### Z OFFSET settings adjustment



1. The recommended distance between the nozzle and print bed (with bed tape securely fastened) is 0.3mm. This should allow two sheets of copy paper to be drawn out smoothly but six sheets of copy paper cannot be passed.

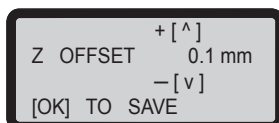

2. Increase/decrease the value based on a scale of 0.1mm.  
 Increasing the value will increase the gap between the print module and print bed by 0.1mm  
 Decreasing the value will also decrease the gap between the print module and print bed by 0.1 mm

## BUZZER

When the buzzer is turned on, the printer will output an audible signal when a button is pressed, print job is finished, or issue is detected.

Buzzer is turned on by default. To switch off the buzzer:

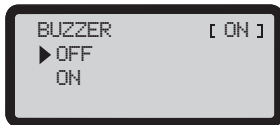

Select "OFF" and press "OK" to change the setting.

## LANGUAGE

You may switch the display language on the printer between English and Japanese.

The default language is English. To switch to Japanese:

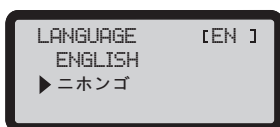

Select "ニホンゴ" and press "OK" to change the setting.

## ENERGY SAVE

LED luminaires are installed in the printing chamber. To save energy consumed, the lighting will go off after idling for 3 minutes (shown as 03M on the display) by default.

To select a longer time interval:

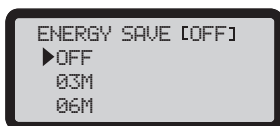

Select "06M" (for auto off after 6 minutes) or "OFF" (for never turn off the LED) and press "OK" to change the setting.

## AUTO LEVEL

The printer will adjust the configuration based on the detecting result automatically while "AUTO LEVEL" is enabled. The printing mode helps to improve printing quality with slower printing speed. You may switch off the function if necessary.

To change the setting of auto-level:

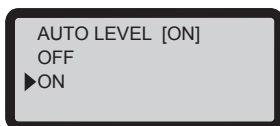

Simply select "OFF" and press "OK" to change the setting.

## RESTORE DEFAULT

All settings can be reset to factory default with a few clicks.

To reset all settings at once:

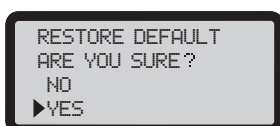

Simply select "YES" and press "OK" to reset.



## STATISTICS

In "STATISTICS", you can check the accumulated print time and last print time.

```

STATISTICS
LIFETIME 00006H
LAST TIME 00H34M
[OK] TO RETURN
  
```

## SYSTEM VERSION

Firmware version is shown here. For stable printing performance, it is advised to keep the firmware up to date. To check for firmware updates, please go to XYZscan/XYZware.

```

SYSTEM VERSION
1.1J
[OK] TO RETURN
  
```

## SPOOL STATS

"SPOOL STATISTICS" provides the information on cartridge level (see REMAINING), and the capacity, color and material of the filament. Press  to read the second page.

```

SPOOL STATS
REMAINING 059M
CAPACITY 240M
[DOWN]>NEXT PAGE
  
```

```

COLOR BLACK
MATERIAL PLA
[OK] TO RETURN
  
```

## HELP

The URL to XYZprinting website can be found here. You may go to the website for the latest information, product documents, tutorial video and more.

```

HELP
WWW.XYZPRINTING.COM
[OK] TO RETURN
  
```

## MONITOR MODE

"MONITOR MODE" shows the temperature of the extruder. See below for the working temperature for the parts in different modes.

```

MONITOR MODE
EXTRUDER 046°C
[OK] TO RETURN
  
```

**!** **Note:** The machine can be turned off only when the cooling fan of the print head stops running after the print is completed. Turning off the power directly may clog the print head.

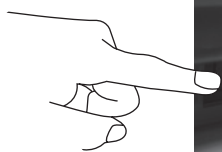

References:  
Please refer to CLEAN NOZZLE to remove the blocks out of the print head.

This section describes how to clean the feed module. After heavy use of printer, if feeding of material becomes difficult or impossible, please follow these steps.

## Preparation of Tools



A. Cleaning brush that comes with the printer

B. Screwdriver (T10) for standard cleaning procedure

## A. Quick Cleaning

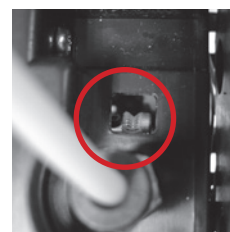
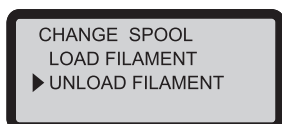

**1** Use the “UNLOAD FILAMENT” function to loosen and remove the filament.

**2** Use the cleaning brush to scrub the feed gear back and forth to remove the chips of filament out of the gear. Replace the wire after the cleaning is completed.

## B. Standard Cleaning

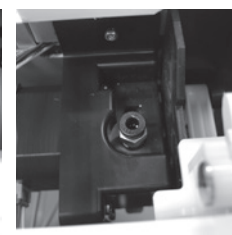
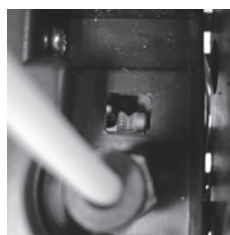
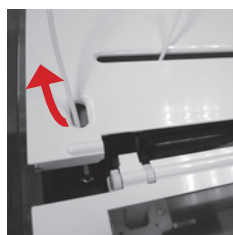
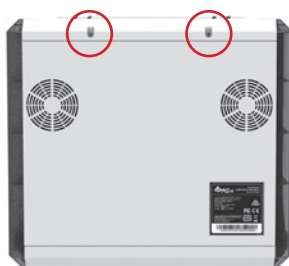

**1** Use the screwdriver to remove the screw and open the top cover.

**2** Press the black rubber fixer on top of hole and pull the guide tube out.

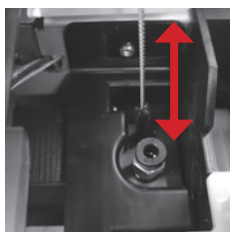

**3** Use the cleaning brush to scrub the gear; after removing residues of filament on the gear, you can insert the guide tube and put the cover back and then enjoy printing again.

# Important Notice

Please peruse the product instruction manual before using this product.

**Note:** Turn off the 3D printer only after the print job is complete and the print head cooling fan stops running. Don't turn off the power directly. Otherwise, the print head may be clogged.



References:  
Please refer to the description of CLEAN NOZZLE function for removing the clogging of the print head.

## Wireless printing

This chapter introduces how to carry out the setting correctly and to operate the wireless printing function. To understand if your product is designed with wireless printing function, please refer to the table below.

- da Vinci 1.1 Plus
- da Vinci Jr 1.0w

### Pre-setting preparation

1. The network printing function is mainly provided for the Intranet. Please set the printer and the computer in same network domain, i.e. connecting to the same Wireless Access Point.
2. Before connecting the printer, adjust the set value of the connected Wireless Access Point. For details of setting method, please refer to the Production Operation Manual or the information provided by the original factory.
3. The Channel Width that can be used by the wireless printing function is **20MHz**. Please refer to the Operation Manual compiled by the original factory for the Wireless Access Point to understand the adjusting method.
4. Please maintain the wireless network function in open status.
5. This machine can support the following connection safety mode. When setting the printer in online status, it is required to input the Public Key related information.

- WEP
- WPA
- WPA2

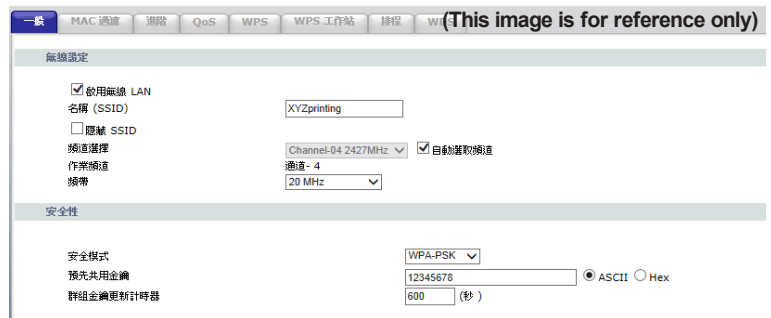
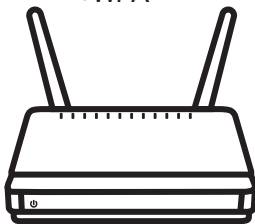

## Start the setting

1. Please make sure the connection between computer and printer properly. After completing the connection, activate the XYZware.

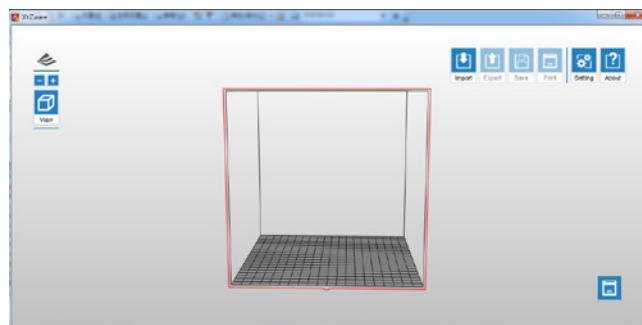

2. Click on the printer monitoring function to open the printer-related information and then click "My Printer" > "Use Wi-Fi" to access the Wireless Printing Set page.

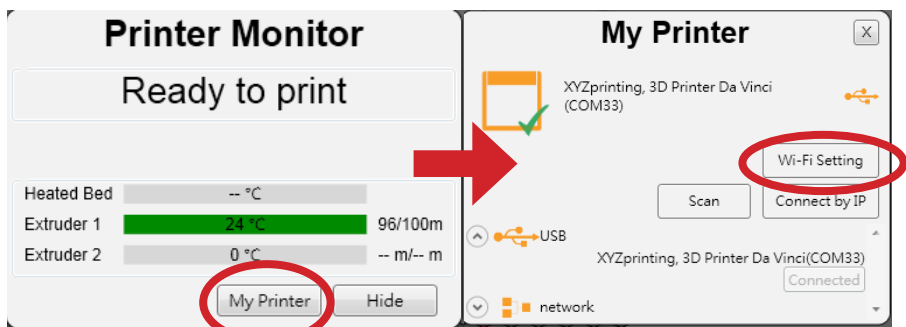
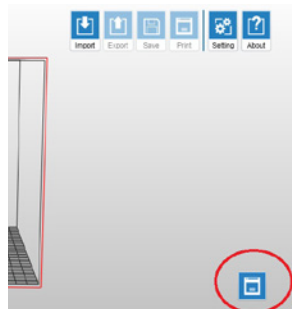

# Wi-Fi Printing

3. Please enter the printer name and then press “SCAN” to scroll down the menu for obtaining the exact Wireless Access Point related information. The description sample will use XYZprinting as the name of Wireless Access Point. After obtaining the desired information, enter the Public Key password and then press “Use Wi-Fi” and XYZware will update the online setting value of printer through USB connecting wire.



Note: Please naming printer and Wireless Access Point in English.

Note: If the printer cannot complete the connection with the Access Point within 90 seconds, then XYZware will discontinue the detection. In this case, please check the operation steps and the network are set correctly.

Note: For the password of Public Key, please refer to the information indicated on the Wireless Access Point setting page, and the length of the password will vary.

4. After completing the printing, please press the “X” key at upper right corner to leave. To reset the wireless network connection, press “STOP WIRELESS NETWORK/CHANGE SETTING” function keys to clear the value set before.



XYZware secures the IP address of the printer and the connection is successful.

INFO>WIFI(SSID)

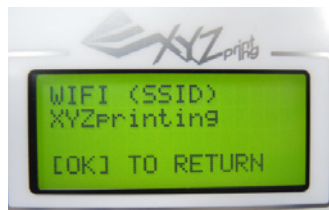

INFO>IP ADDRESS

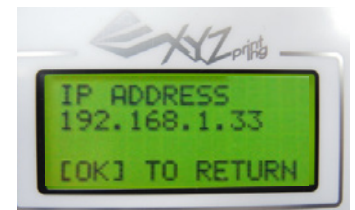

At this time, confirm the connection is completed through the information displayed on the printer.

5. Remove the USB connecting wire and then restart XYZware and the machine is ready for online printing again.

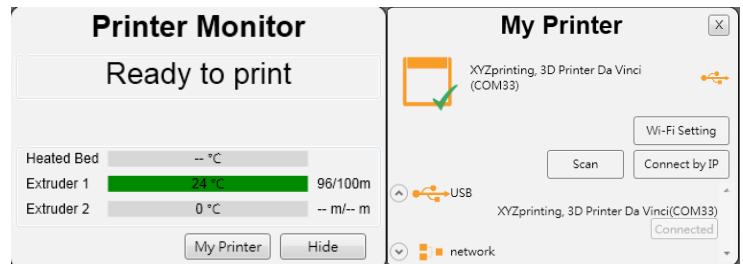
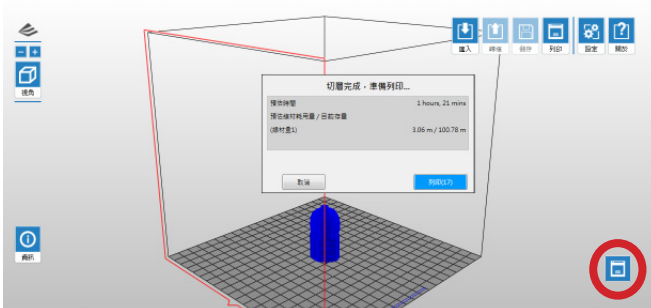

The monitoring function of printer can be used to confirm the on-line status and the IP information of the connected printer.

- ⚠ Note: After restarting the printer, IP information will be erased. Please setting again.
- Note: The performance of wireless network may be affected due to various environment and power of machine. For detailed information, please contact the wireless equipment provider or refer to the original factory's manual. XYZprinting cannot provide tested data for specific equipment.

## Other Information

1. This product is guaranteed for specific period from the purchase date against any breakdown within the scope of proper and reasonable usage of their product as defined by XYZ printing.  
Presentation of warranty card with the product will ensure free service and repair of inherent faults in the product within the warranty period. However, the following items are separate and dealt with under conditions of other related warranty services:
  - Printing modules / printing platforms / motor modules
  - Attached consumables (including housing, packing materials, power cords, USB cables, coil consumables, user manuals and software CD's): no warranty is given.
2. To protect your right and interests, please request that the dealer fill in the product information and purchase date on the product warranty card, and also make sure that they affix their official seal.
3. Please keep this warranty card in a safe place because if it is lost or destroyed a new one will not be issued.  
Make sure to present the card if you require any repairs, service or maintenance on the product during the warranty period.
4. XYZprinting may levy charges under any of the following circumstances:
  - Man-made damages: In the case of damage to the product caused by incorrect use, wrong installation, abnormal wear, physical damage or deformation caused by falls or blows, burnt circuits resulting from actions from the user, broken or bent interface or pins or any other physical damage to the product caused by misuse.
  - Incompatibility issues: anything unconnected with product malfunctions such as conflict with electronic equipment, expectation of use, noise of operation, speed, discomfort or heat.
  - Damage caused by force Majeure (such as lightning strike, fire, earthquake, floods, civil disturbance or war or any other event beyond human control).
  - Any request of warranty service after expiration of the warranty period.

If you need warranty service, please contact the original dealer or email us at [supportus@xyzprinting.com](mailto:supportus@xyzprinting.com). If you need more information about our warranty services, please log in to [www.xyzprinting.com](http://www.xyzprinting.com), select "support (product support)" where you will find complete details of all the warranty conditions.

### Federal Communications Commission (FCC) Statement

You are cautioned that changes or modifications not expressly approved by the part responsible for compliance could void the user's authority to operate the equipment.

This equipment has been tested and found to comply with the limits for a Class B digital device, pursuant to part 15 of the FCC rules. These limits are designed to provide reasonable protection against harmful interference in a residential installation. This equipment generates, uses and can radiate radio frequency energy and, if not installed and used in accordance with the instructions, may cause harmful interference to radio communications. However, there is no guarantee that interference will not occur in a particular installation. If this equipment does cause harmful interference to radio or television reception, which can be determined by turning the equipment off and on, the user is encouraged to try to correct the interference by one or more of the following measures:

- Reorient or relocate the receiving antenna.
- Increase the separation between the equipment and receiver.
- Connect the equipment into an outlet on a circuit different from that to which the receiver is connected.
- Consult the dealer or an experienced radio/TV technician for help.

XYZprinting is not responsible for any radio or television interference caused by using other than recommended cables and connectors or by unauthorized changes or modifications to this equipment. Unauthorized changes or modifications could void the user's authority to operate the equipment.

This device complies with Part 15 of the FCC Rules. Operation is subject to the following two conditions: (1) this device may not cause harmful interference, and (2) this device must accept any interference received, including interference that may cause undesired operation.

This device complies with FCC radiation exposure limits set forth for an uncontrolled environment and it also complies with Part 15 of the FCC RF Rules. This equipment must be installed and operated in accordance with provided instructions and the antenna(s) used for this transmitter must be installed to provide a separation distance of at least 20 cm from all persons and must not be co-located or operating in conjunction with any other antenna or transmitter. End-users and installers must be provided with antenna installation instructions and consider removing the no-collocation statement.

- 1.The mobile device needs to support wireless printing.
- 2.Install XYZprinting App from Android or iOS system.





**1** Open the Play Store from your Android browser or App store of iOS system to search “XYZprinting” and download the application to your device.

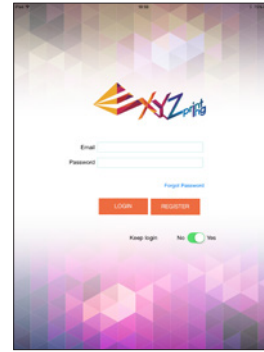

**2** Please register an account at XYZprinting official website before logging in.

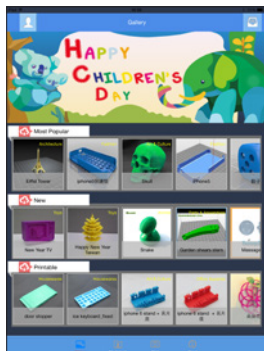

**3** After log in, you will see “most popular”, “new” and “printable\*” three folders for you to choose.

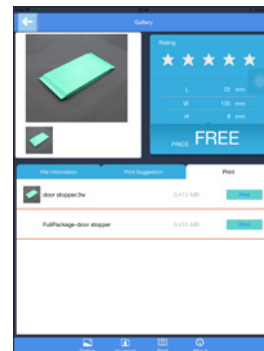

**4** Select the object you want to print.

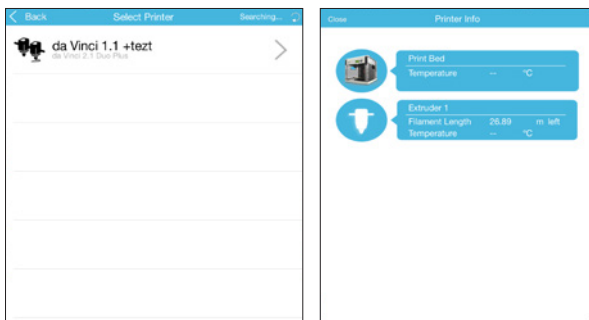

**5** Select the printer and confirm the printer information, tap “Confirm to print”, the file will be sent to the printer and ready to print.

**Note:**

- 1.Ensure the mobile device and the printer are connected on the same wireless network.
- 2.Transferring a print file over a wireless network may take more time than transferring a print file from a USB mass storage device.

\*The printable file is .3w format which can print from App directly. Some prints are.stl files that need to export into .3w format via XYZware before printing. If the file requires payment, please follow the payment instruction.

# Warning

- Do not let children operate this device without adult supervision. Electric shock hazard. Moving parts can cause serious injury.
- Do not place the printer on an unbalanced or unstable surface. Printer may fall or tumble causing harm and/or injury. Printer may fall or tumble causing harm and/or injury.
- Do not place any objects on top of the printer. Liquids and objects that fall into the printer can lead to printer damage or safety risks.
- Do not use flammable chemicals or alcohol wipes to clean this device.
- Do not disassemble or replace the printer cover with non-XYZprinter covers.
- Do not touch heated surfaces during or after operation. Heated surfaces can cause severe burns.
- Insert and secure the power cord firmly for proper usage and to avoid potential electricity and fire dangers.
- Do not attempt to service the printer beyond the instructions specified in this document. In the case of irrecoverable problem, contact XYZprinting service center or your sales representative.

# Warning!