

# Congratulations on the purchase of your HP DeskJet printer!

**H**ere's what comes in the box. If anything's missing, talk to your HP dealer or call Customer Support (see "Customer Support" in Chapter 4 of the user's guide for the telephone number).

You'll need to buy a printer cable that supports bidirectional communication (IEEE-1284-compliant), such as HP C2950A.

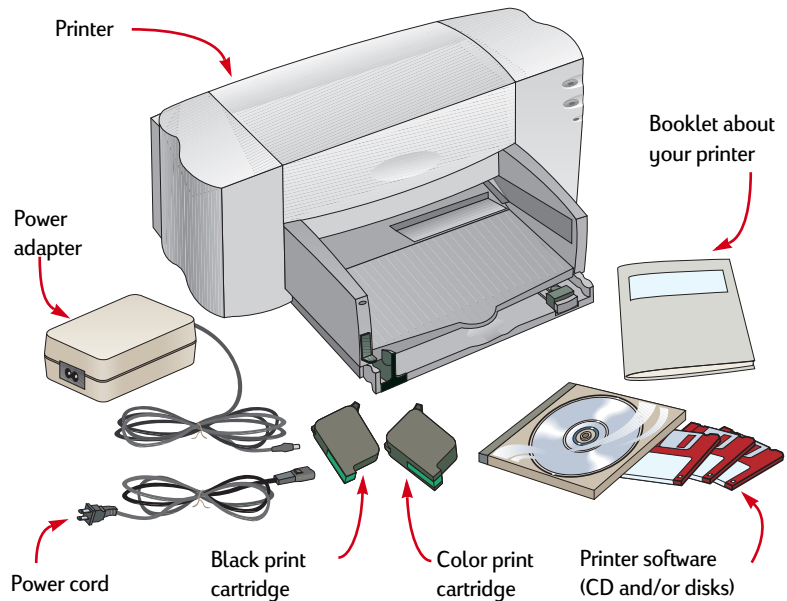

Microsoft Windows or Windows NT 4.0 is required to use this printer. Please refer to the minimum system requirements listed in Chapter 5 of the user's guide.

If your computer does not have a CD-ROM drive and disks were not included with your printer, see page 45 of the user's guide for information on getting printer software.

STEP

1

# Unpack Your Printer



- 1 Remove the packing tape from the outside of the printer.

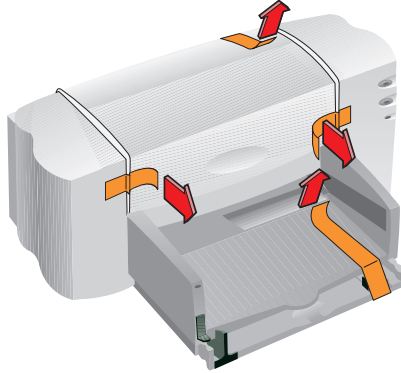

Now would be a good time to take a second and make note of the serial number on the bottom of your printer.

Write the serial number in the blank provided inside the front cover of your user's guide. This way you can easily access the serial number when you need it.

- 2 Open the top cover and remove the plastic packing material from the inside of the printer.

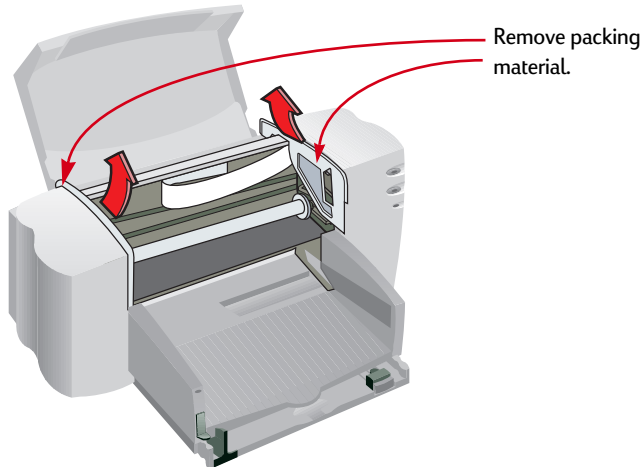

- 3 Close the top cover.

STEP

2



# Connect Your Printer to Your Computer

- 1 Make sure the computer is turned off.
- 2 Lift the cable access door on the back of the printer.
- 3 Plug the end of the cable with the notches into the printer. Snap both clips into the notches.

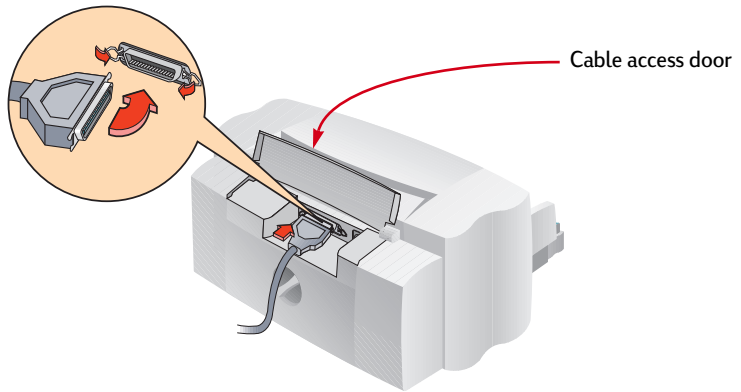

You'll need to buy a printer cable that supports bidirectional communication (IEEE-1284-compliant), such as HP C2950A.

- 4 Plug the other end of the cable into the computer, and tighten the screws.

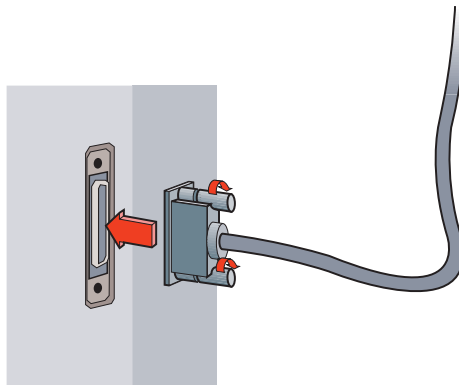

STEP

# 3



## Plug in Your Printer

- 1 Lift the cable access door and plug the power adapter cord firmly into the connector.

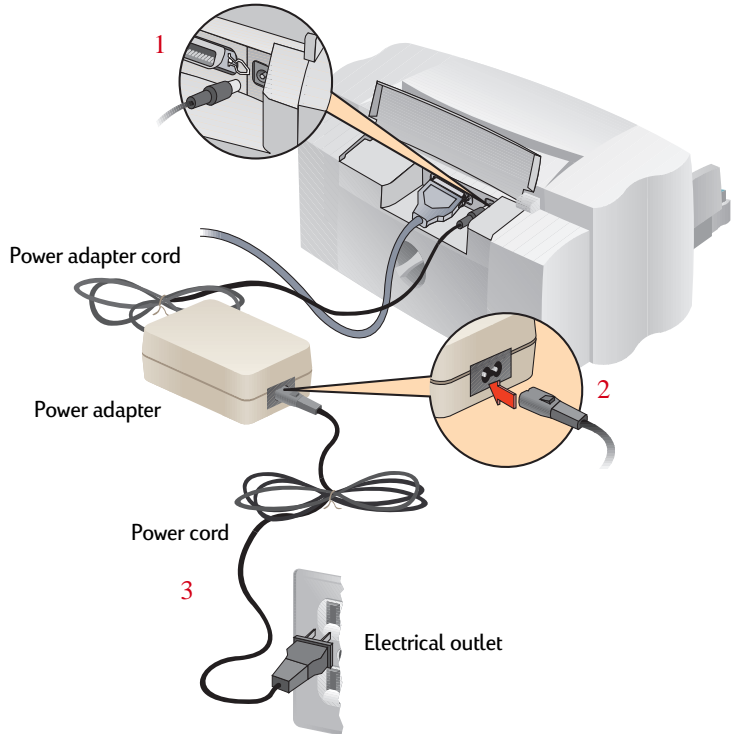

- 2 Plug the appropriate end of the power cord into the power adapter.
- 3 Plug the other end of the power cord into an electrical outlet.

STEP

4



# Insert the Print Cartridges

- 1 Press the Power  button to turn on your printer.

The power light comes on and the print cartridge light  blinks.

- 2 Open the top cover.

The cartridge cradles move to the center of the printer.

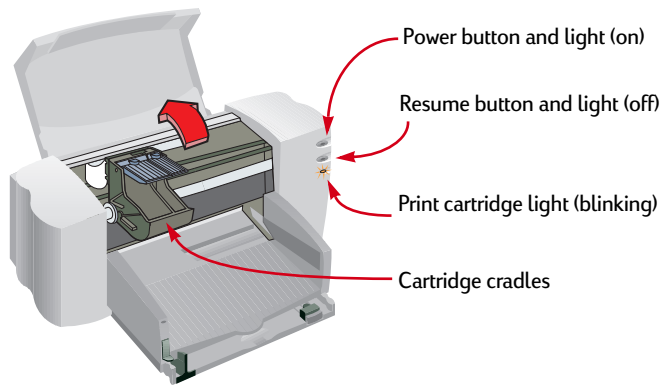

When buying print cartridges check the part numbers carefully to make sure you buy the right ones.



Black  
HP 51645G



Large Black  
HP 51645A



Tri-Color  
HP C1823A

- 3 Carefully remove the protective vinyl tape from the color and black print cartridges.

Be sure not to touch the ink nozzles or the electrical contacts.

Black print cartridge

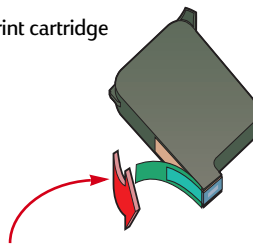

Remove tape

Color print cartridge

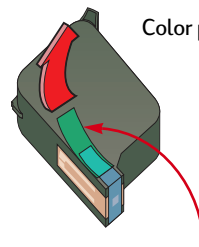

Remove tape

These print cartridges have been specifically designed to work with your printer.

- 4** For each print cartridge, lift the green cradle latch. With the electrical contacts toward the rear of the printer, push the cartridge firmly down into the cradle. Close the latch.

You will hear a click, and the cartridges will sit firmly in the cradles. You must insert both cartridges for the printer to operate.

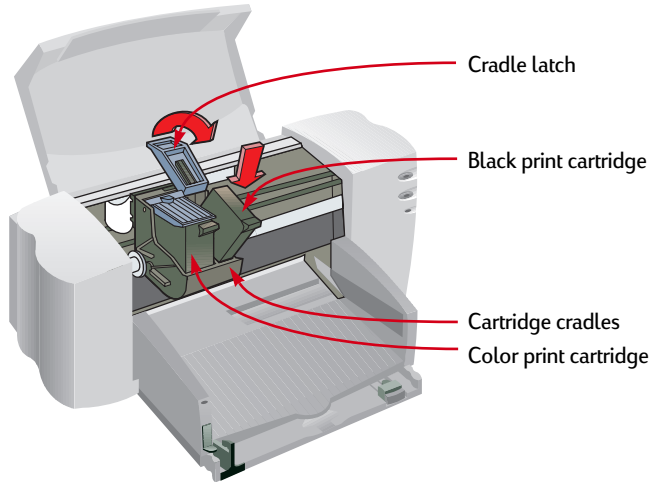

- 5** Close the top cover.

If the print cartridge light  continues to blink, take out both cartridges and reinsert them.

The print cartridge light  continues to blink for a few seconds and then goes off. (You'll hear the cartridges return to their home position on the right side of the printer.)

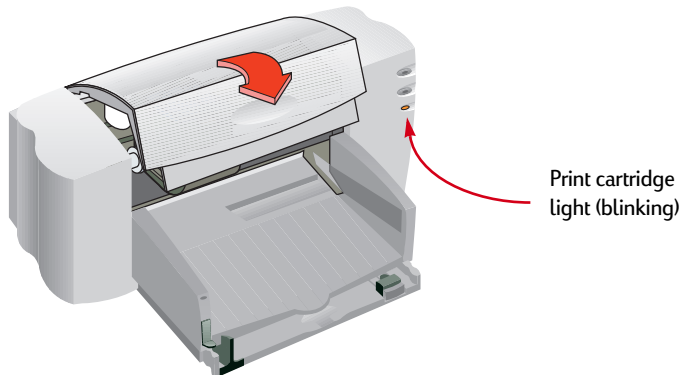

STEP

5

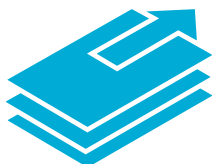

# Load Paper in Your Printer

- 1 Grab the sides of the IN drawer and pull the drawer out. Slide the paper adjusters out as far as possible. (You can flip up the OUT tray to see better.)

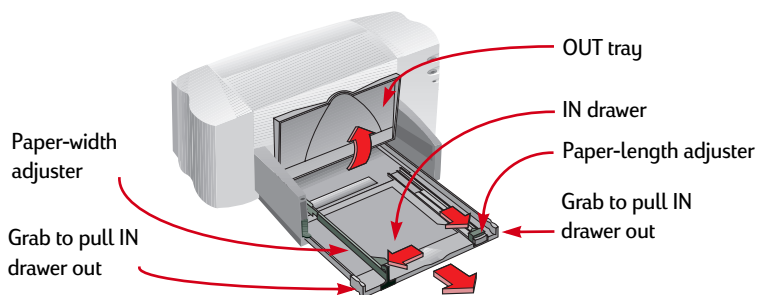

- 2 Load the paper in the IN drawer.

You can insert as much paper as fits comfortably under the tab on the paper-length adjuster.

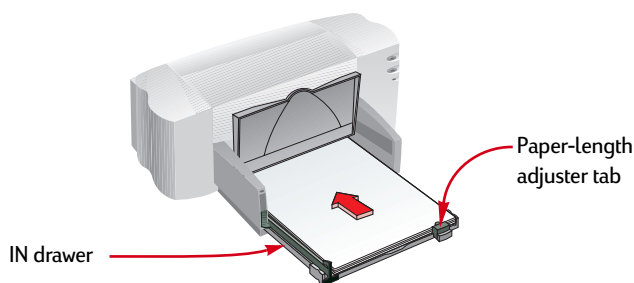

- 3 Move both paper adjusters in until they fit snugly against the paper's edges and slide the IN drawer all the way back in.

Flip the OUT tray back down if it's up.

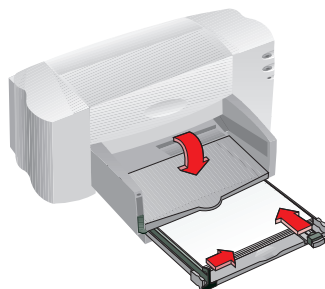

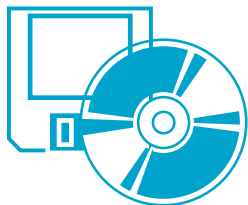

# Install the Printer Software

To ensure successful installation of the printer software:

- 1 Make sure your computer is fully set up and operational.
- 2 Check that the printer is properly set up and ready to print using the instructions in this setup guide.
- 3 Make sure that the printer is connected directly to the computer (remove any switch boxes or other devices using the same port) and check that all cable connections are firm.
- 4 Make sure the computer and the printer are turned on.
- 5 Close any virus protection programs or other software programs that are running on your computer (see page 14 for instructions).

If your computer does not have a CD-ROM drive and disks were not included with your printer see page 45 of the user's guide for information on getting printer software.

Follow the installation instructions for the operating system on your computer.





## Installing from the CD: Windows 95, Windows 98, and Windows NT 4.0

If the “New Hardware Found” dialog box appears at any time during the installation, click in the upper-right corner of the box, or click Cancel.

Depending upon the operating system on your computer, your boxes might differ from the Windows 95 boxes shown throughout this document and the user’s guide.

Windows NT 4.0 users: You need to set the HP DeskJet Printer as the default printer. See page 14 for instructions.

### 6 Insert the CD into your CD-ROM drive.

After a few seconds, the HP DeskJet opening screen appears.

### 7 If the opening screen does not appear, do the following:

- a. Click *Start* on the taskbar, and then click *Run*.



- b. Type `d:\setup` and click *OK*.

If your CD-ROM drive is assigned to a letter other than “d”, type that letter instead or browse to locate the CD-ROM drive.

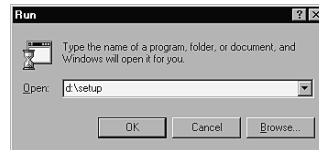

### 8 When the opening screen appears, click *Install the HP DeskJet 710C Series Software on your PC* and follow the instructions on the screen.

If something goes wrong, see page 13.

### 9 When the installer instructs you to restart Windows, the installation is almost complete. Remove the CD from your CD-ROM drive and restart Windows.

## 10 If a Communication Test dialog box appears, click *Test*.

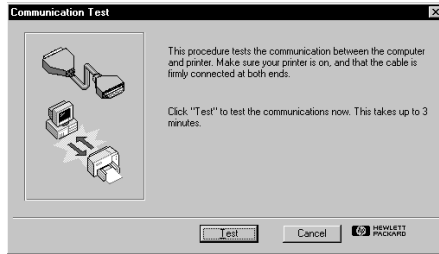

## 11 Do one of the following:

- If the test is successful, skip the rest of this section and go to page 15.
- If the test is not successful, click *Troubleshoot* and try to correct this problem. If you cannot correct this problem, click *OK*. For more information about printer communications, see page 14.

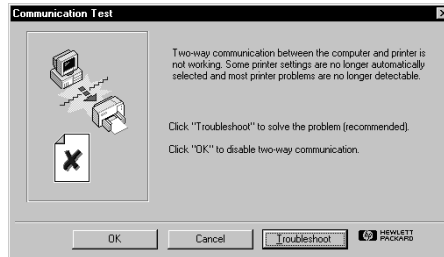

## Installing from the CD: Windows 3.1x

6 Insert the CD into your CD-ROM drive.

7 In the Program Manager, click *File* and then click *Run*.

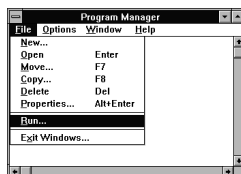

**8** Type `d:\setup` and click *OK*.

If your CD-ROM drive is assigned to a letter other than “d”, type that letter instead or browse to locate the CD-ROM drive.

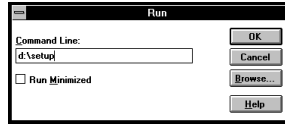

**9** When the opening screen appears, click *Install the HP DeskJet 710C Series Software on your PC* and follow the instructions on the screen.

If something goes wrong, see page 13.

**10** When the installer instructs you to restart Windows, the installation is almost complete. Remove the CD from your CD-ROM drive and restart Windows.

**11** If a Communication Test dialog box appears, click *Test*.

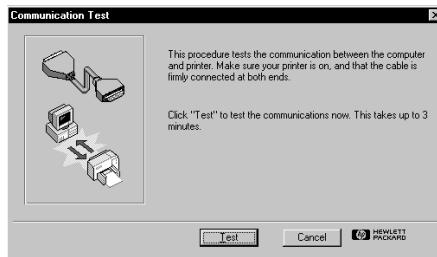

**12** Do one of the following:

- If the test is successful, skip the rest of this section and go to page 15.
- If the test is not successful, click *Troubleshoot* and try to correct this problem. If you cannot correct this problem, click *OK*. For more information about printer communications, see page 14.

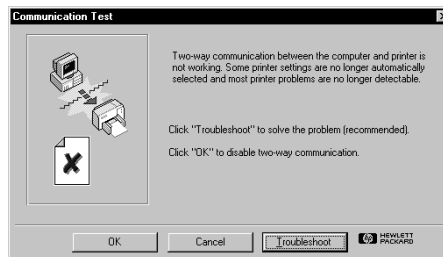



## Installing from Disks: Windows 95, Windows 98, or Windows 3.1x

- 6** Insert Disk 1 into the disk drive.
- 7** Windows 95 and Windows 98 users: click *Start* on the taskbar and then click *Run*.  
  
Windows 3.1x users: in the Program Manager, click *File*, and then click *Run*.
- 8** Type `a:\setup` and click *OK*.  
  
If your disk drive is assigned to a letter other than “a”, type that letter instead or browse to locate the disk drive.
- 9** When the opening screen appears, click *Install the HP DeskJet 710C Series Software on your PC* and follow the instructions on the screen.  
  
If something goes wrong, see page 13.
- 10** When the installer instructs you to restart Windows, the installation is almost complete. Remove the disk from your disk drive and restart Windows.
- 11** If a Communication Test dialog box appears, click *Test*.
- 12** Do one of the following:
  - If the test is successful, skip the rest of this section and go to page 15.
  - If the test is not successful, click *Troubleshoot* and try to correct this problem. If you cannot correct this problem, click *OK*. For more information about printer communications, see page 14.

## If you have problems installing

- 1** Make sure your printer is on and all connections are firm. Ensure that no other peripherals (such as a scanner, switch box, tape backup, etc.) are connected to the printer cable. Make sure your cable is IEEE-1284-compliant.
- 2** Exit your software program and turn off the computer and the printer. Turn on the printer and then turn on the computer.
- 3** Close any virus protection programs that are running on your computer. Right-click the virus protection program icon in the taskbar status area, and then click *Disable*.
- 4** Uninstall the printer software using the instructions on page 55 of the user's guide.
- 5** Try the installation process again.
- 6** If you get a message that two-way communication is not working, click *OK* and continue with the rest of the installation. For more information on the communication test, see page 14.

## If you're still having problems with the installation

Try the installation process again. If you still have problems, call an authorized HP dealer or call your HP Customer Care service technician. For the phone number nearest you, see page 45 in the user's guide.

If you are installing printer software, close all software programs except the HP DeskJet installer.

When all software programs are closed, only Program Manager appears.

## Additional information about installing your printer software

### Closing software programs

#### In Windows 3.1x:

- 1 While holding down ALT, press TAB to locate an open software program.
- 2 When you locate an open software program, release both keys.
- 3 Click *File*, and then click *Exit*.
- 4 Repeat steps 1 through 3 for each open software program.

#### In Windows 95, Windows 98, and Windows NT 4.0:

- 1 Right-click the software program on the taskbar and click *Close*.
- 2 Repeat step 1 for each open software program.

### Setting your printer as the default

To set your printer as the default in Windows NT 4.0:

- 1 Click *Start* on the taskbar, click *Settings*, and then click *Printers*.
- 2 Right-click the *HP DeskJet 710C Series Printer* icon and choose *Set As Default*.

### Communications test and two-way communications

The printer software tests the communication between your computer and your printer and tells you if you have two-way communication. Two-way communication allows your printer and computer to communicate and gives you access to all the features of your HP DeskJet printer. The cable between your printer and computer must be bidirectional to allow two-way communication—the HP IEEE-1284-compliant Parallel Interface Cable (C2950A) is best. If you do not have two-way communication, your printer cannot send messages to the computer. However, you can still print.

# Align the Print Cartridges



You're ready for the final step in setting up your printer: aligning the cartridges to make sure you get the best print quality. Be sure to align the cartridges whenever you install a new cartridge.

- 1 Be sure there's paper in the printer's IN drawer and that the drawer and the paper adjusters are pushed in.
- 2 Double-click the HP Toolbox icon on the computer screen:

Windows 95, Windows 98, or NT 4.0



HP DeskJet  
710C Series  
Toolbox

Windows 3.1x



HP DeskJet  
710C Series  
Toolbox

- 3 Click the *Printer Services* tab, then click *Align the print cartridges*. Follow the instructions on the computer screen.

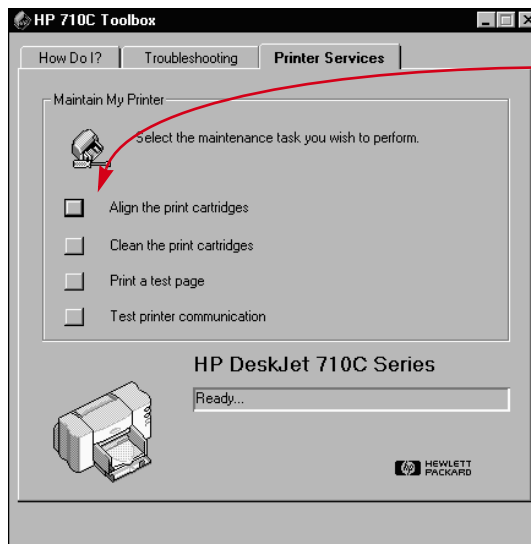

Click here to align the print cartridges.

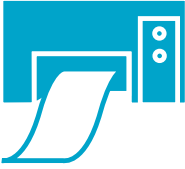

# Print a Page

You're done setting up your printer! While you still have the HP Toolbox open, you can try printing a page, just to see what your printer can do.

- 1 On the **Printer Services** tab of the HP Toolbox, click *Print a test page*.

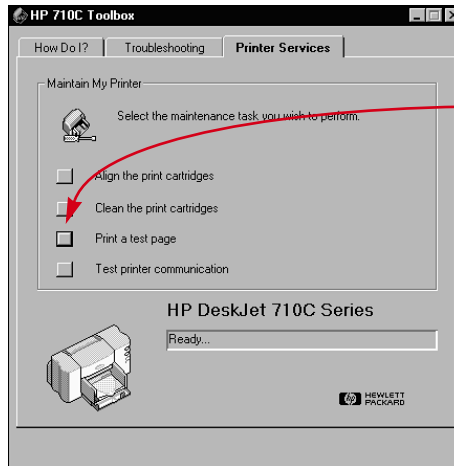

Click here to  
print a test page.

- 2 Check out the results!

You're ready to print your own work. For instructions, tips, and some fun suggestions, see the user's guide.



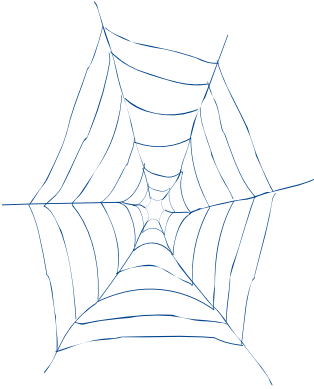

## Support and Registration

For DeskJet support and printer registration, please refer to the HP Customer Care Web site:

<http://www.hp.com/go/support>

HP is dedicated to giving you fast and accurate customer support. So that we can give you the best service possible, please have the following information available:

- **What is the serial number of your printer?** (The serial number label is on the bottom of the printer.) \_\_\_\_\_
- **What model of printer do you have?** HP DeskJet 710C
- **What brand and model is your computer?** \_\_\_\_\_
- **What version of printer software are you using?** (See your Printer Setup dialog box for the name of the selected driver.) \_\_\_\_\_

# The HP DeskJet Printer User's Guide

English

## Acknowledgments

Microsoft® and MS-DOS® are U.S. registered trademarks and Windows™ is a trademark of Microsoft Corporation.

TrueType™ is a U.S. trademark of Apple Computer, Inc.

Arial® and Times New Roman® are U.S. registered trademarks of The Monotype Corporation.

Snowdrift™ is a trademark of Agfa Division of Bayer Corporation.

Creepy™ is a trademark of the Monotype Corporation which may be registered in certain jurisdictions.

Kodak is a trademark of the Eastman Kodak Company.

## Notice

The information contained in this document is subject to change without notice.

Hewlett-Packard makes no warranty of any kind with regard to this material, including, but not limited to, the implied warranties of merchantability and fitness for a particular purpose.

Hewlett-Packard shall not be liable for errors contained herein or for incidental or consequential damages in connection with the furnishing, performance, or use of this material.

No part of this document may be photocopied, reproduced, or translated to another language without the prior written consent of Hewlett-Packard Company.

## Printing History

Edition 1, March 1998

© Copyright 1998 by Hewlett-Packard Company



# Table of Contents

---

<b>CHAPTER 1</b>	<b>Printing Basics</b>	<b>1</b>
	How to Choose Paper	2
	How to Put Paper in the Printer	3
	How to Print	5
	Printer Software	8
<hr/>		
<b>CHAPTER 2</b>	<b>Beyond the Basics</b>	<b>13</b>
	How to Print on Different Paper Sizes	14
	How to Print on Both Sides of the Paper	16
	How to Flip a Document	18
	About Color	19
	About pictures	21
	About Text	23
<hr/>		
<b>CHAPTER 3</b>	<b>What You Can Print</b>	<b>25</b>
	Envelopes	26
	Labels	29
	Transparencies	31
	Photographs	33
	Cards	34
	Banners	36
	Iron-On Transfers	39
<hr/>		
<b>CHAPTER 4</b>	<b>Getting Help When Things Go Wrong</b>	<b>40</b>
	Click your way to a solution	40
	Printer Communications	44
	Buttons and Lights	44
	HP Customer Care	45
<hr/>		
<b>CHAPTER 5</b>	<b>More About Your Printer</b>	<b>48</b>
	Print cartridges	49
	Uninstalling the software	55
	Printing from DOS	56
	Specifications	57
	Ordering supplies and accessories	60
	Ordering information	62
	Regulatory Notices	63
	Limited Warranty Statement	64
<hr/>		
<b>INDEX</b>		<b>65</b>

# Printing Basics



How to  
Choose Paper



How to Put  
Paper in  
the Printer



How to Print



Printer Software:  
Your Printer's  
Remote Control

**A**lthough your printer can do some pretty fancy stuff, most of the time you'll be printing words and pictures on paper. The process is simple: First choose the paper you want to use; load the paper in your printer; choose your print settings from the printer software; and then print from the computer software program you're using.

If you want to know more about the printing basics, read on. And don't miss the tips on each page.



## Paper Pointers

### GET THE RIGHT PAPER

Use HP paper for vivid color and the sharpest text. Here are some of your choices:

- **HP Premium Inkjet Paper.** Its matte finish captures brighter colors and sharper images for more brilliant documents and presentations.
- **HP Deluxe Photo Paper.** It uses Kodak Image Enhancements technology to give you excellent skintones and true-to-life landscape colors.
- **HP Bright White Inkjet Paper.** It produces high-contrast colors and sharp text. This bright white inkjet paper gives you the ability to print on both sides without show-through.
- **HP Premium Photo Paper.** It produces spectacular photos that look and feel like traditional photos.

HP papers are available at most office supply or computer supply stores or by calling HP Direct (see page 62).



## How to Choose Paper

Most plain photocopy paper works fine in your printer, particularly paper that is marked for use in inkjet printers. To get the best results, use one of the Hewlett-Packard papers, which were developed especially for HP inks and your printer.

### What to Consider

**Size.** You can use any size paper that fits easily within the paper adjusters of the printer.

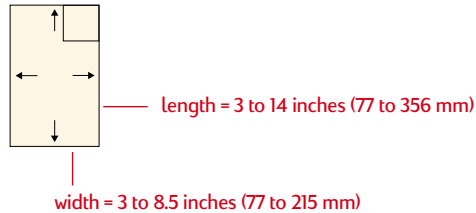

**Weight.** You can choose from a wide range of paper weights, as listed on page 57. Use 20–24-pound or 75–90 g/m<sup>2</sup> plain paper for multipurpose, everyday use.

**Brightness.** Some papers are whiter than others and produce sharper, more vibrant colors. Use HP Deluxe Photo Paper or HP Premium Photo Paper for documents with photographs; use HP Bright White Inkjet Paper or HP Premium Inkjet Paper for documents with any other pictures.

**Surface smoothness.** The smoothness of the paper affects how crisp the printing looks on the paper. Paper with a high cotton content (25% to 100%) tends to offer greater surface smoothness. Glossy, coated paper works well for pictures and charts (where you want crisp lines with intense, high-quality colors) and for photocopying.

**Opacity.** Opacity refers to the degree to which printing on one side of the paper shows through to the other side. Use paper high in opacity (or thicker paper) for two-sided printing. HP Photo Paper and HP Premium Heavyweight Inkjet Paper are ideal for two-sided projects.



# How to Put Paper in the Printer

Take a second to load the paper correctly in the IN drawer. Make sure all the paper in the drawer is the same size and type, and that the paper adjusters rest snugly against the paper. The printer will do the rest.

Let's walk through the process step by step:

- 1 Slide out the paper-width and paper-length adjusters to make room for the paper.

If you want, you can slide out the IN drawer to insert the paper more easily. You can flip up the OUT tray if you want to see better.

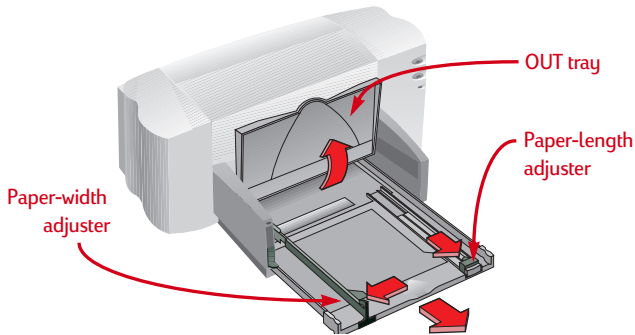

- 2 Fan the edges of the paper stack to separate the pages. Then tap the stack on a flat surface to even it up.

You can insert up to 3/8 in or 10 mm (about 100 sheets) at a time.

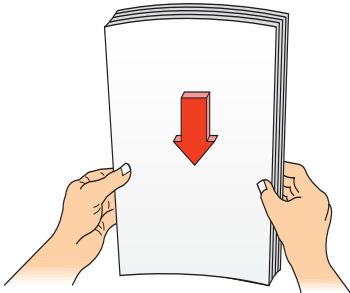

## Paper Pointers

### PAPER THAT MIGHT NOT WORK

- Highly textured stock such as linen might not print evenly; the ink could bleed into these papers.
- Extremely smooth, shiny, or coated papers not specifically designed for inkjet printers could jam the printer and might actually *repel* ink.
- Multi-part forms (such as duplicate or triplicate forms) could wrinkle in the printer or get stuck; the ink is also more likely to smear. In addition, only the top page will have print on it.
- Paper in poor condition—with tears, dust, wrinkles, or curled or bent edges, or that doesn't lie flat—could jam the printer.





## Paper Pointers

### PRINTSIDE DOWN

Most paper prints better on one side than on the other. This is especially true for coated or specially treated paper. The print side is usually indicated on the paper package.

### PRINTING ZONE

Your printer can't print right to the edge of the paper. Be sure to set the margins so that the document falls within the printable area, or part of it could be cut off. For details, see page 57.

- Put the paper in the IN drawer, print side down.

Push the paper in toward the back of the paper drawer until it stops.

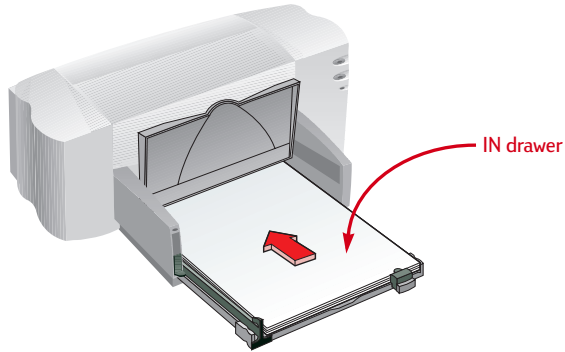

- Slide the paper adjusters in so they fit snugly against the edges of the paper.

Make sure the paper still lies flat in the drawer and that the paper fits easily under the tab of the paper-length adjuster. (See page 28 for more information if you're loading small-sized paper.)

- Push the paper drawer back in and flip the OUT tray back down.

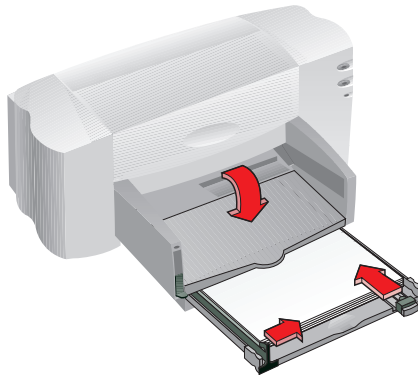



# How to Print

- 1 Check your print settings in the HP print settings box. (See page 9 to find out how to get to the box.)

If you're printing one copy, on plain paper with portrait orientation, the default settings will work fine for you. (Chapters 2 and 3 explain why you might want to change the settings for different types of printing.)

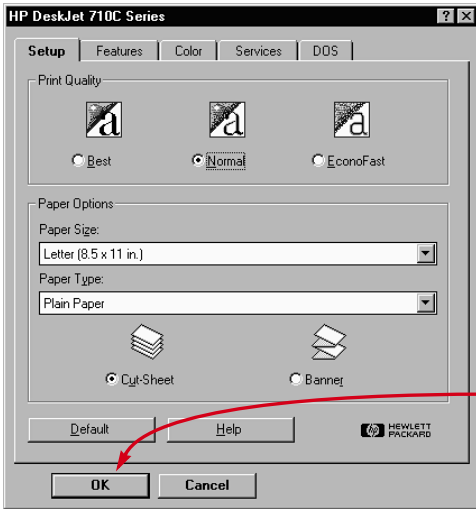

HP print settings box

Click OK to save your settings.

- 2 Click **OK** in the HP print settings box to save your settings.
- 3 Click **OK** in the Print box of your software program to start printing.

(You might need to click *File* and then *Print* to reach the Print box.)

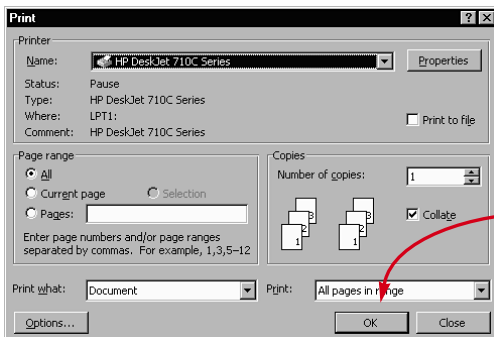

The *Print* box in your software program

Click OK to print.

That's all there is to it. The printer will print one page at a time until it finishes, delivering each printed page into the printer's OUT tray.

- ! Depending upon the operating system on your computer, your boxes might differ from the Windows 95 boxes shown throughout the manuals.



## Handy Hints

### PRINTING FROM DOS

For information about printing from DOS programs, turn to page 56.

### PICK A PAPER TYPE

If you're using HP paper in your printer, in the HP print settings box select the right paper type for your paper.

- Select *Plain Paper* for
  - HP Bright White Inkjet Paper
  - HP Banner Paper
- Select *HP Premium Inkjet Paper* for
  - HP Premium Inkjet Paper
  - HP Greeting Card Paper
  - HP Iron-On T-Shirt Transfers
  - HP Premium Inkjet Heavyweight Paper
- Select *HP Deluxe Photo Paper* to use Kodak Image Enhancements technology with HP Deluxe Photo Paper.
- Select *HP Premium Photo Paper* for HP Premium Photo Paper.



## What If

### THE PRINTOUTS ARE SLOTCY AND UNEVEN

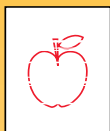

If you are using a new paper, this could be the problem. See page 2 for the best paper choices. If not, check the print cartridges—they might be dirty or running out of ink. To find out how to clean or replace them, open the HP Toolbox (see page 11) and click the *Printer Services* tab for cleaning or the *How Do I?* tab for replacing cartridges.

### YOU CAN'T FIND THE JAMMED PAPER

If you can't see the paper causing the jams, check to see if a label has come unglued from a label sheet while going through the printer.

## While You're Printing

It takes a few moments for the printing to start, while the printer gets information from the computer. Even after it's started printing, the printer might pause occasionally to receive more information.

### If you run out of paper before you've finished

The printer will prompt you to add more paper. Put the paper in the IN drawer, and then press the Resume  button on the front of the printer.

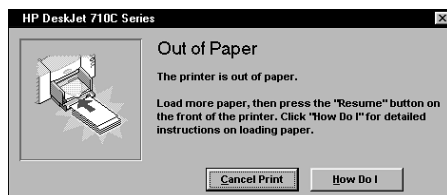

### If the paper jams in the printer

If the paper jams in the printer, you'll usually be able to pull the paper out from either the IN drawer or the OUT tray. Then press the Resume  button on the front of the printer. The printer will turn off and then on again on its own. You'll need to resend your job to the printer.

Sometimes the paper jams in the back of the printer. If you can't reach the jammed paper, turn the knob on the rear access door at the back of the printer 1/4 turn counter clockwise and remove the door.

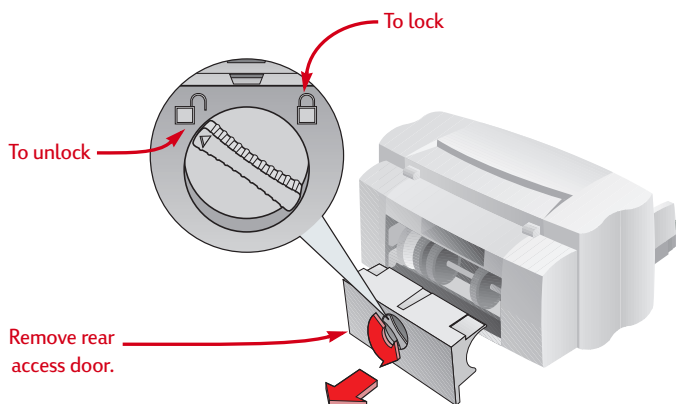

Pull the jammed paper out of the printer and then replace the door, making sure to lock the door by turning the knob clockwise to the locked position. Press the Resume  button on the front of the printer and resend your print job.

## Troubleshooting

If a problem occurs during printing, you'll see a message on your screen telling you what's wrong and how to fix it.

If you don't get a message but you notice that something is wrong or you don't like how the printout looks, click the *Troubleshooting* tab in the HP Toolbox and follow the instructions on the screen. (See page 11 to find out how to get to the HP Toolbox.)

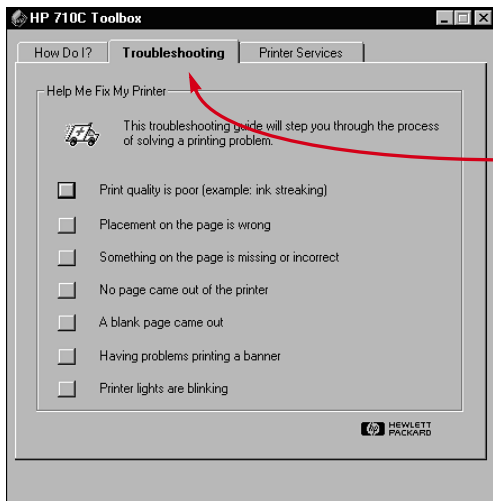

Click the *Troubleshooting* tab.



### What If

#### YOU AREN'T SEEING ANY MESSAGES

If you seem to be having a problem but you aren't seeing any messages on your screen, it might be because you don't have two-way communications (see page 44 for more information).



### Handy Hints

#### HP ON THE WEB

You can get the latest product information, troubleshoot problems, and download updated printer software from the HP Customer Care Web site at <http://www.hp.com/go/support>





# Printer Software: Your Printer's Remote Control

Although your printer has a couple of buttons on it, you really control the printer remotely through your software program and through the printer software you installed on your computer.

Instead of pushing buttons on a remote control, you make your selections in the HP print settings box and the HP Toolbox. (But, just like a remote control, sometimes these two boxes are hard to find.)

## Tell the Printer What You Want

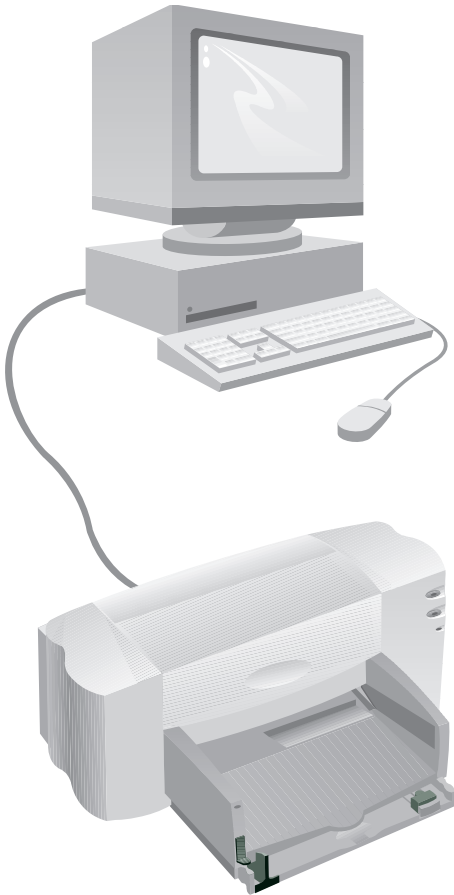

### Printer Software

#### HP Print Settings Box

How to find it: see page 9

What it does: see page 10

#### HP Toolbox

How to find it: see page 11

What it does: see page 12

## See the Results!

# The HP Print Settings Box: How to find it

You can select settings such as the paper type, paper size, orientation and print quality in this box. How you find the box differs depending on which software program and which operating system you're using.

Try these strategies from the File menu of your document, and you're sure to get there.

## Try This

- 1 Click *File* and then click *Print*.
- 2 Then click whichever button you see—*Properties*, *Setup*, or *Printer*. (Clicking *Options* at this point won't get you there.)
- 3 If you still don't see the box, click *Setup*, *Options* or *Properties*.

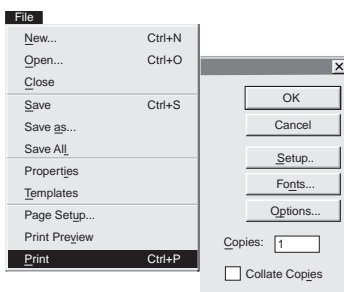

## ...Or Try This

- 1 If *Print* isn't there, then click *Printer Setup* or *Print Setup*.
- 2 Then click whichever button you see—*Setup* or *Options*.

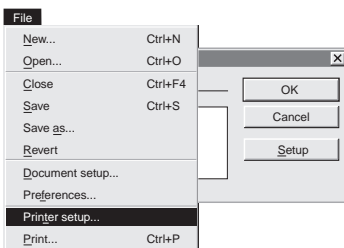

## You're There!



**!** FOR MORE INFORMATION ABOUT THE HP PRINT SETTINGS BOX, SEE ONLINE HELP.

# The HP Print Settings Box: What it can do for you

Click a tab and then click a setting.

Show your finished work at its best.  
Click *Best* print quality.

Select the appropriate settings.  
Choose the right paper size and type for the job.

Save time and ink.  
Click *EconoFast* print quality.

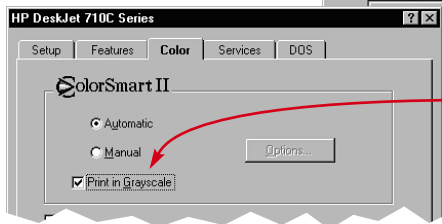
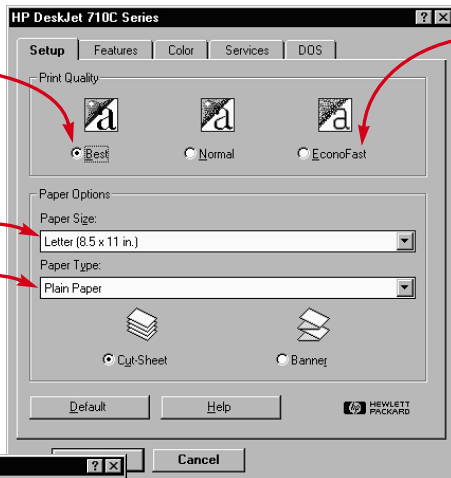

Save time and color ink.  
Click here to print drafts of color documents in shades of gray.

Save money and trees.  
Print on both sides of the paper (when available).

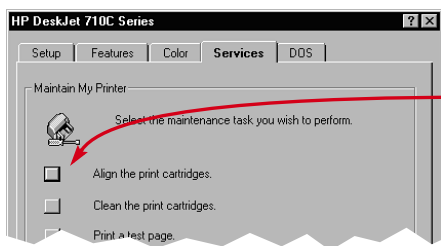
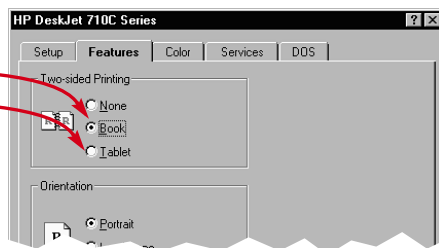

Print clearly.  
Align your black and color cartridges, and clean them when necessary, as described in online troubleshooting.

Click OK to save your settings.



# The HP Toolbox: How to find it

The HP Toolbox tells you how to print and how to troubleshoot your printing problems. It even allows you to align and clean your print cartridges. For each Windows system, here are a couple of places to find the HP Toolbox.

## Windows 95, Windows 98, and Windows NT 4.0

Double-click the HP Toolbox shortcut icon. This shortcut is on your desktop.

If you've removed the HP Toolbox icon, click *Start*, point to *Programs*, point to *HP DeskJet Utilities*, and then click *HP DeskJet 710C Toolbox*.

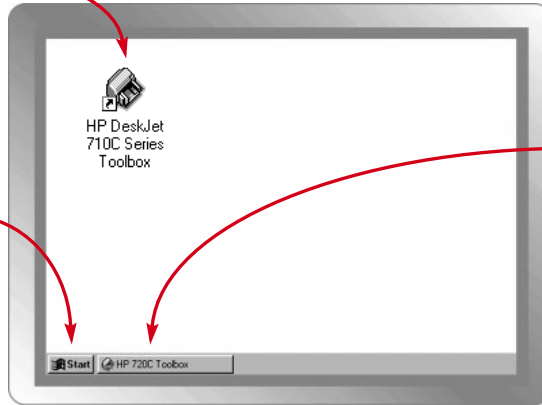

Click the *HP Toolbox* button. This button appears on the Taskbar at the bottom of the screen when the HP Toolbox is open and whenever you're printing.

## Windows 3.1x

If you close the HP Toolbox, it'll reappear when you're printing. Or you can double-click it in the HP DeskJet Utilities group in the Program Manager.

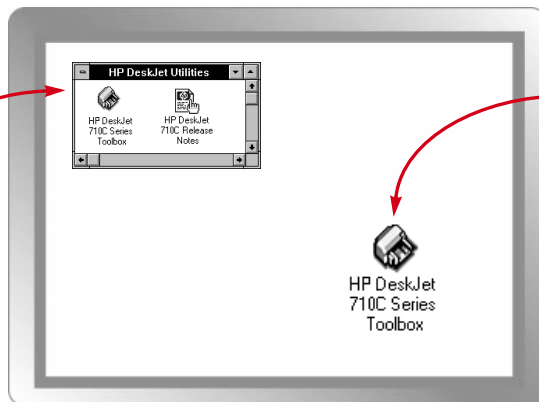

Double-click the HP Toolbox icon. It's on your desktop when you start your computer.



# The HP Toolbox: What it can do for you

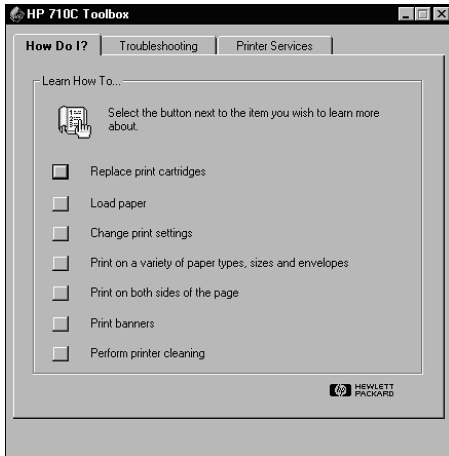

## How Do I?

Follow the steps to print what you want.

## Troubleshooting

Find your way to a solution when things go wrong.  
(See page 40 for more information.)

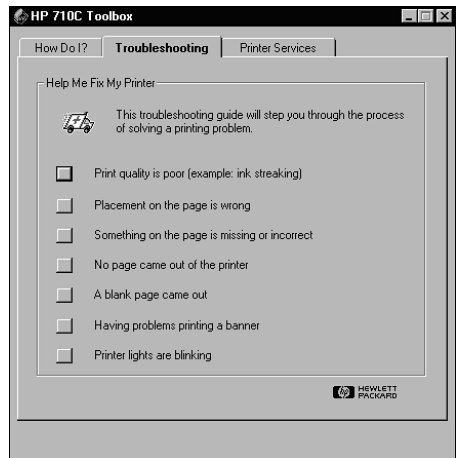

## Printer Services

Keep your printer in working order.



# Beyond the Basics



How to Print on  
Different  
Paper Sizes



How to Print on  
Both Sides of  
the Paper

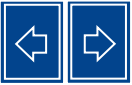

How to Flip a  
Document



About Color



About Pictures



About Text

**W**ith the printing basics down, you're ready to learn more about what your printer can do for you and how you can get the most out of your printer.



## Paper Pointers

### PREPRINTED PAPER

You can buy pre-printed checks or business forms (such as invoices and statements) that are designed for inkjet printers. When you print on these forms, just remember to load the printed side face down, with the top of the page going into the printer first.

### CREATE YOUR OWN BUSINESS FORMS

You can create customized business forms or business cards with your own logo, name, and address and print them as you need them. Software programs usually provide templates that can help you design the forms.

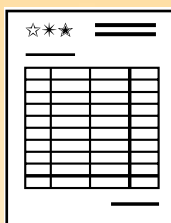

# How to Print on Different Paper Sizes

Most of the time, when you print on plain paper, cards, labels, and envelopes, you select one of the standard sizes in the Paper Size box on the Setup tab of the HP print settings box. But you're not limited to the sizes listed. Just make sure the size of the paper falls within the following dimensions (so the printer rollers can pick up the paper):

**Width:** 3 to 8.5 inches (77 mm to 215 mm)

**Length:** 3 to 14 inches (77 mm to 356 mm)

Then follow these steps:

- 1 In the HP print settings dialog box, click the *Setup* tab, and then select *Custom* in the *Paper Size* list. (See page 9 to find out how to get to the HP print settings box.)

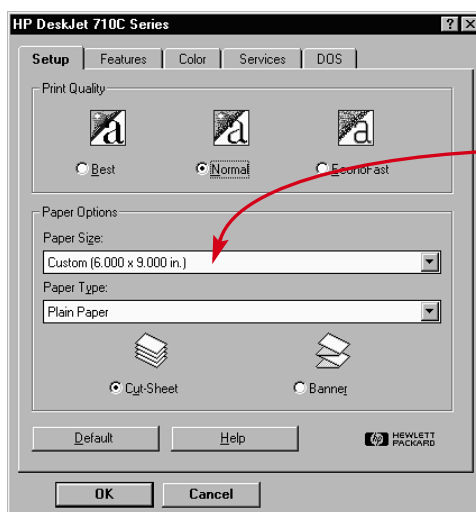

Select Custom.

- 2 Type the dimensions of the paper in the *Custom Paper Size* box, and then click *OK*.

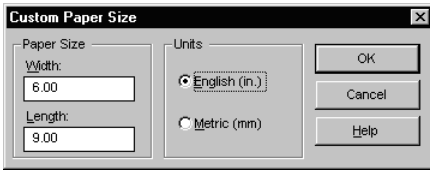

- 3 Load the paper in the printer and print as you would for normal paper sizes.

For small paper sizes, you might need to push the small green sliding adjuster in further to hold the paper snugly lengthwise, as described on page 28.

#### **AFTER PRINTING**

Change the *Paper Size* back to *Letter* or *A4*, or to whatever paper size you'll be printing on next.



## Paper Pointers

### CHANGE THE SHAPE

Even though you print on flat paper, there's no reason to leave it that way. Buy an origami book and learn to change the shape of your printed paper. Or add shape to your printed piece by gluing small charms, buttons, or dried flowers onto card stock.





## Paper Pointers

### PAPER THAT WON'T SHOW THROUGH

Look for any paper in which pictures and text printed on one side don't show through on the other. Collect sample sheets that are 24-pound (90 gsm) or heavier, and test them to make sure they do the job.



## What If

### THE SECOND SIDE PRINTED LIKE THIS:

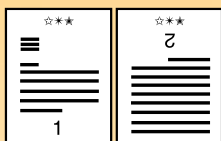

- You might have selected *Tablet* instead of *Book* in the HP print settings box. (See step 3.)
- You might have forgotten to rotate the paper after the first side printed. Print the document again, carefully following the directions on your screen.



# How to Print on Both Sides of the Paper

The easiest way to save paper is to print on both sides of it. Just put the paper through the printer twice: Select a two-sided printing option and follow the directions on your screen.

- 1** Load the paper in the IN drawer.  
Make sure there's no paper in the OUT tray.
- 2** In the HP print settings box, click the *Features* tab. (See page 9 to find out how to get to the HP print settings box.)
- 3** Then click *Book* or *Tablet*.

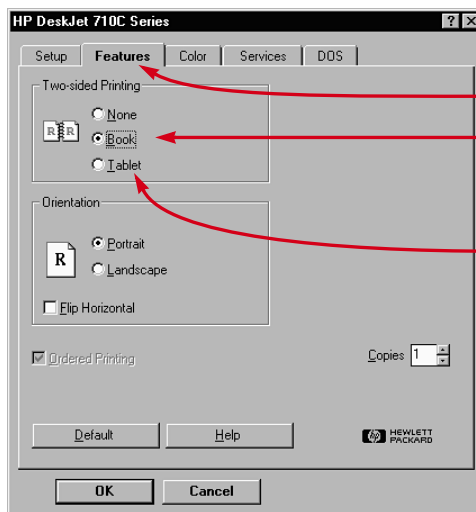

Click the *Features* tab.

Click *Book* so the sheets can be bound on the left.

Click *Tablet* so the sheets can be bound at the top.

- 4** Print your document.

The printer automatically prints only the odd-numbered pages. The printer then displays a message on your computer screen telling you how to reload the paper.

- 5** Put the printed pages back in the IN drawer of the printer.

The following illustrations show how to put the paper back in the printer for the *Book* option and the *Tablet* option.

**Book option**

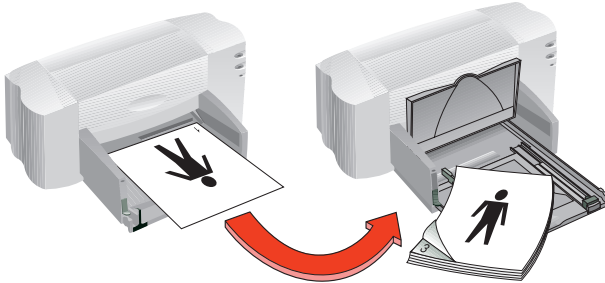

Odd-numbered pages print first.

Reload to print even-numbered pages.

**Tablet option**

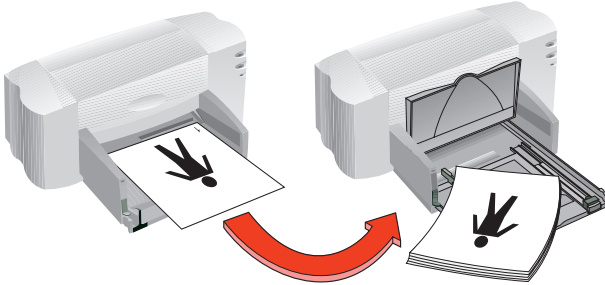

Odd-numbered pages print first.

Reload to print even-numbered pages

The printer prints the even-numbered pages on the reverse side of the odd-numbered pages.

- 6** When the paper is ready, flip the OUT tray down again and click *Continue* in the message box.

The printer prints the even-numbered pages on the reverse side of the odd-numbered pages.

**AFTER PRINTING**

Change the *Two-Sided Printing* option back to *None*.



**What If**

**BOTH PAGES PRINTED ON ONE SIDE OF THE PAPER**

You put the paper print side down when you replaced it in the printer. Print your document again, paying special attention to the instructions on your screen.



**THE INK SMEARED**

The ink might not have dried completely, so wait a bit longer before you print the second side. You can shorten drying times by reducing the quality of the printing—for example, change from *Normal* to *EconoFast* print quality on the *Setup* tab of the HP print settings box.



## Handy Hints

### WHY FLIP A DOCUMENT?

You'll want to flip a document when you use an iron-on transfer (see page 39); the image you're transferring is flipped back to its original orientation when it's ironed onto the cloth.

You might want to flip a document before printing it on a transparency; then you can make notes on the back of the transparency and easily wipe them off later without scratching the transparency.

### CHEAPER THAN LIGHT

Did you know that when your printer is turned on it uses less energy than most light bulbs—a mere 12 watts while it's printing.

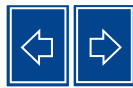

# How to Flip a Document

When you print a flipped document, the text and pictures are flipped horizontally (mirrored) from what you see on your computer screen.

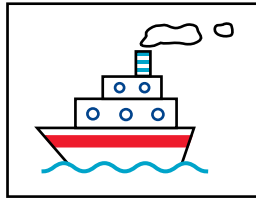

The original

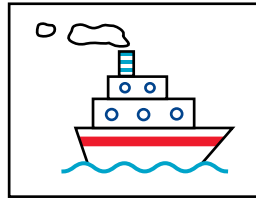

The flipped document

- 1 Load the paper in the IN drawer.

If you're printing on transparencies, see page 31. If you're printing on iron-on transfers, see page 39.

- 2 In the HP print settings box, click the *Features* tab, and then click *Flip Horizontal*. (See page 9 to find out how to get to the HP print settings box.)

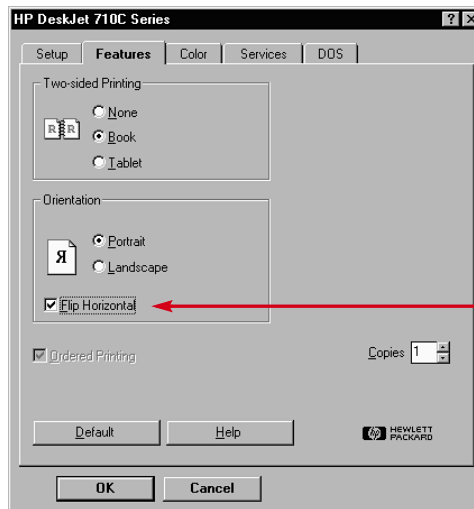

- 3 Print your document.

The text and pictures are reversed. Hold the printout up to a mirror to see how the final product will look.

### AFTER PRINTING

- Click the *Flip Horizontal* box again to clear it.
- If you used transparencies or iron-on transfer paper, remove it from the IN drawer and replace it with plain paper or whatever you'll be using next.



## About Color

One of the simplest ways to make your documents clearer and visually interesting is to print in color. The printer combines the four colors in the two print cartridges—cyan, magenta, yellow, and black—to match the colors of the text and pictures (even photographs) on your screen.



Cyan



Magenta



Yellow



Black

## Turning Off Color

The color text and pictures that you create in your documents will automatically print in color. You can print drafts of your color documents in grayscale if you're going to photocopy them in black and white or if you want to save time and ink.

- In the HP print settings box, click the *Color* tab, and then click *Print in Grayscale*.



A "✓" in this box means that color is turned off.

Your color documents will print in shades of gray until you change the setting.

If you want exceptional quality black and white documents, use *Best* or *Normal* mode with the grayscale setting. In these modes the printer will use some color ink.



## What If

### THE PRINTED COLORS DON'T MATCH THE SCREEN COLORS

Because of the physics of how color is made on screen (with light) and at the printer (with dyes and pigments), there might be a slight mismatch.

### THE COLORS AREN'T AS VIVID AS THEY SHOULD BE

You might be printing on the wrong side of the paper. If turning the paper over makes no difference, change the print quality to *Best*. If you're using a special paper, change the *Paper Type* setting to match the paper (see page 5).





## Handy Hints

### COLORSMART II TECHNOLOGY

Your printer is especially smart about printing color. (That's why HP calls the technology ColorSmart II!) When you print a document in color, the printer marks each element in your document—text, full-color photographs, and graphics (such as pie charts with solid blocks of color)—and renders each at its vivid best—even those printed from the Internet. You get high-quality color at less cost than making color copies at a copy shop.

## Adjusting the Color

Like a full-featured camera, your printer can “autofocus,” using HP’s ColorSmart technology to automatically make adjustments that will give you the best quality color printing. But if you prefer, you can manipulate the settings yourself to produce the effect you want:

- 1 In the HP print settings dialog box, click the *Color* tab and then click *Manual*. Then click *Options*.

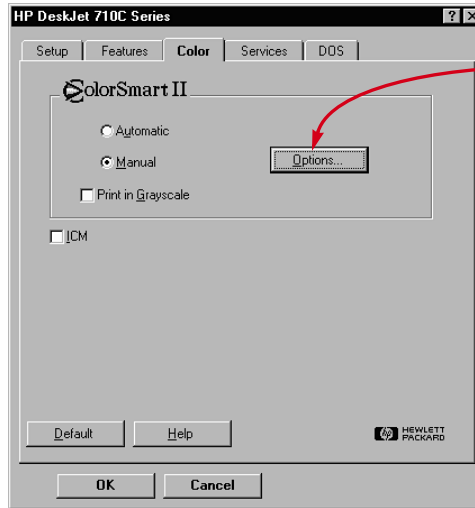

- 2 Change the *Intensity* or *Halftoning* settings.



To find out more about these settings, click *Help*.



# About pictures

Pictures, graphics, and art are some generic terms used to describe the elements in your documents that aren't text (such as charts, illustrations, decorative elements, and photographs).

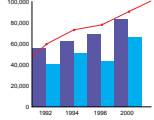

Charts and graphs



Illustrations



Decorative elements



Photographs

To put a picture in a document you want to print, you first need to get it into an electronic form (a computer file). Then it's simple to copy it into a document—the user's guide for the software program you're using tells you how. Here are some possibilities for getting your pictures into electronic form.

- Draw the pictures yourself, using the drawing tools in a software program.



- Use ready-made clip art—you can get it from a variety of sources, including the Internet and your software programs. See "Need a picture?" for more ideas.



- Scan the pictures yourself. Use your own scanner or gather your pictures and rent a scanner at a local copy shop.

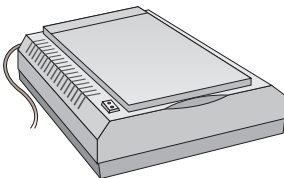

## Handy Hints

### NEED A PICTURE?

Look through computer magazines for the names of companies that sell clip art. They'll be happy to send you full-color pictures of their extensive offerings. Or browse in the art sections of bookstores for books of copyright-free pictures.

Remember that it is against the law to copy any photograph unless you have been given specific permission to do so by the person or company who owns the original.



## What If

### PICTURES TAKE LONGER THAN YOU EXPECT TO PRINT

Be patient. Because of their complexity, pictures, particularly color photographs, can take a long time to print.

If you're printing a draft, you can speed up printing by using *EconoFast* print quality (directions on page 10), though the quality won't be the best. Or you can turn off color altogether and print a fast, inexpensive black draft.

### PICTURES DON'T LOOK AS CRISP AS THE SCANNED ORIGINAL

The picture might have been scanned at a higher number of dots per inch (dpi) than your printer can print. To get the best results, scan photographs at 150 or 300 dpi. If you scan them at a higher dpi, you won't improve the print quality, and the pictures will take longer to print.

- Get your photos scanned at your local camera shop. For a small fee, you can have an entire roll of pictures put on a CD-ROM disk. Be sure to ask your camera shop to also put a CD-viewing application on the disk with your pictures.

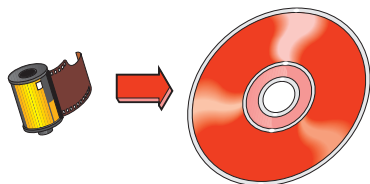

- Take a digital picture. A digital camera bypasses film entirely and makes the picture into a computer file. Call a full-service copy shop or a camera supply store about renting one.

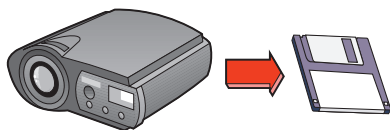



# About Text

The words on the page look the way they do because of the fonts you use when you type the text in your software program. Fonts are sets of characters (uppercase and lowercase letters, numerals, and punctuation marks) with a particular design or look to them. Each font has a name, such as Times New Roman or Creepy.

**CREEPY**  
**ABCDEFGHIJKLMNOPQRSTUVWXYZ**  
**ABCDEFGHIJKLMNOPQRSTUVWXYZ**  
**0123456789!@#\$%^&\*()\_+?><`=-**

## Choosing Fonts

When you're choosing fonts, you can think of them in these groups:

- Serif fonts have tags (tails) on the letters, which lead your eye from one character to the next. Serif fonts are good for blocks of text.
- Sans serif fonts have no tags. Their clean lines make them ideal for headlines and other large text.
- Special-purpose fonts. These include decorative and script fonts usually used as special effects for small amounts of text in large sizes.

Times New Roman ← Serif

Arial ← Sans serif

Snowdrift ← Special purpose



## Handy Hints

### SOME LETTERS LOOK LIKE PICTURES

Wingdings are symbol (or picture) fonts that you type using the letter or number keys on your keyboard. You format them like text—you can add color, change their size, and so on.

But how do you know which letter or number to type for a picture? Make a chart! Simply type every letter and number on your keyboard twice, on two lines, one beneath the other. Make all the text big enough so the pictures will be clear—30-point text works well. Then highlight every other line and format it as Wingdings.





## Handy Hints

### SEEING FONTS CLOSE UP

Most software programs give you just a peek at the look of a font. But if you're working in Windows 95, it's easy to print a sample page of each font. Simply click *Start* and then point to *Settings*. Click *Control Panel* and then double-click *Fonts*. Double-click any font you want to preview and then click *Print* to print a sample.

## Using Fonts

Many software programs include a *Font* command that lists the available fonts. Usually you'll select the text and apply the font (or include the font as part of a style definition). See the user's guide for the program you're using to find out how to select fonts for your text.

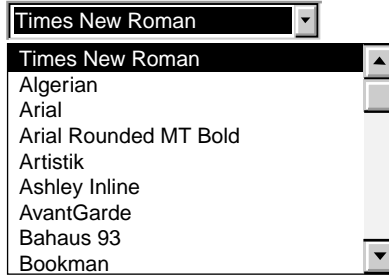

## Buying Fonts

Fonts are included with most software programs and operating systems you purchase. You can buy additional fonts and install them on your computer, where they're stored in your computer's memory.

You can buy two types of fonts for your computer:

- TrueType fonts, which are fonts that can be scaled to different sizes and that look exactly the same on your computer screen and on the printed page.
- Type 1, or postscript, fonts (if you're using a type manager).

# What You Can Print



Envelopes



Labels



Transparencies



Photographs



Cards



Banners



Iron-On Transfers

**W**ith the printing basics down, you're ready for some results. Here are some ideas of what your printer can print on different media types:

- Envelopes—either one at a time or as a stack.
- Labels—label your file folders or get those monthly mass mailings out the door.
- Transparencies for important presentations.
- Photographs—make personalized buttons or name tags.
- Business cards, recipe cards, or invitations to opening night.
- Banners to attract visitors to your sales booth.
- Iron-on transfers on sun visors printed with your company logo.



## Handy Hints

### FOLLOW YOUR SOFTWARE

If your software program includes an envelope printing feature, follow those instructions instead of the procedure provided here.



## Paper Pointers

### ENVELOPES THAT WON'T WORK

Avoid shiny or embossed envelopes, or those that have clasps or windows. (Use transparent labels instead for these sorts of envelopes.) Also, envelopes with thick, irregular, or curled edges or with areas that are wrinkled, torn, or otherwise damaged could get stuck in the printer.

## Envelopes

Your printer provides two methods for printing envelopes:

- If you're printing a single envelope, you can use the single-envelope slot and leave your paper in the IN drawer. This allows you to print the envelope and then a letter.
- If you're printing a stack of envelopes, use the IN drawer.

## How to Print a Single Envelope

- 1 In the HP print settings box, click the *Setup* tab, then select an envelope size in the *Paper Size* box. (See page 9 for how to get to the HP print settings box.)

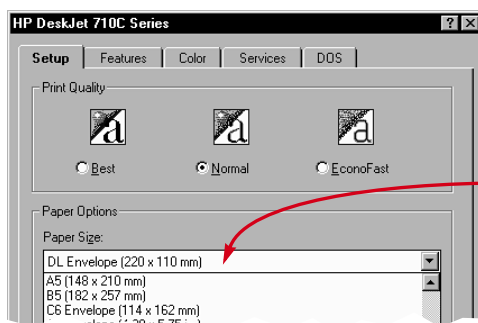

Select an envelope.

- 2 Slide the envelope into the single-envelope slot, as shown here, until it stops.

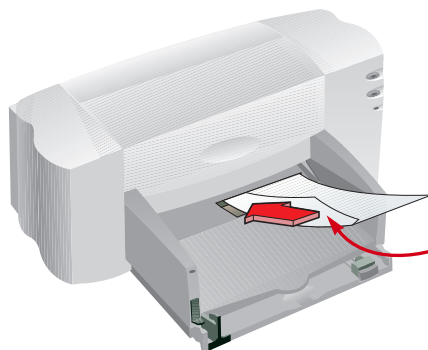

Flap side up and to the left

- 3 Print the envelope.

### AFTER PRINTING

- Change the paper size in the HP print settings box back to *Letter* or *A4* or to whatever you will be printing on next.

# How to Print a Stack of Envelopes

- 1 In the HP print settings box, click the *Setup* tab, then select an envelope size in the *Paper Size* box. (See page 9 for how to get to the HP print settings box.)

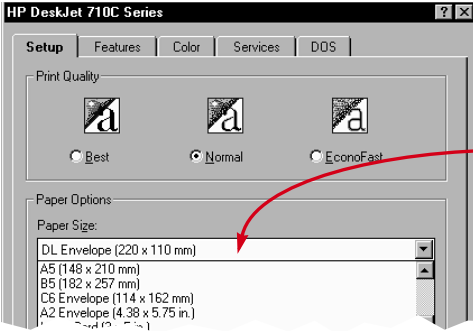

Select an envelope.

- 2 Slide both of the paper adjusters out. Make sure the IN drawer is empty.

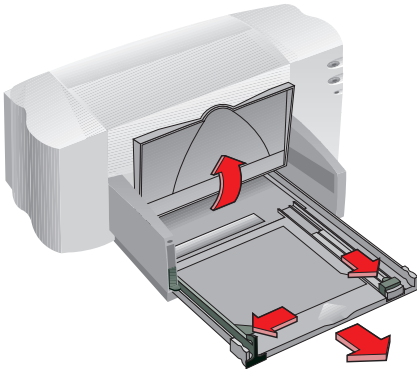

- 3 Put a stack of up to 15 envelopes in the printer, as shown below. (If you're using thick envelopes, you might need to reduce the number.)

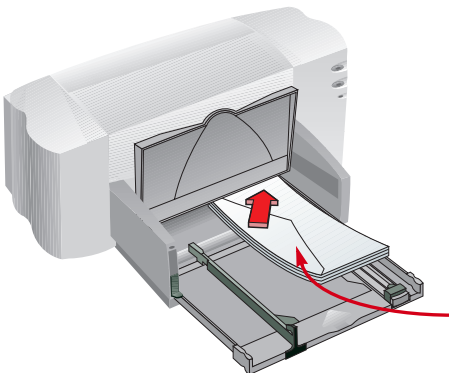

Flap side up and the flap to the left



## What If

### THE PRINTER WON'T PICK UP THE ENVELOPE

If you're printing a single envelope using the single-envelope slot, you might not have pushed the envelope far enough into the printer. If you're printing a stack of envelopes, you might have included too many in the stack. Reduce the number and try again.

### YOUR ENVELOPES PRINT LIKE THIS

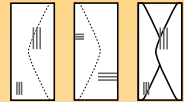

You might have put the envelope in incorrectly. Or you might not have selected an envelope in the *Setup* tab of the HP print settings box. Or you might not have made a special adjustment required by your word processor. (See the word processor user's guide for instructions.)





## Paper Pointers

### MAKE A MATCH

If you want to print your cards or invitations on predesigned paper, don't stop there. You can buy envelopes designed to match the paper. Try HP Greeting Card Paper.

### WRAP A LETTER

An envelope is like gift wrap: It can impress and intrigue, provoking the receiver to open it. You can buy envelopes made from recycled out-of-date maps or recycled art magazine pages. Browse a large stationery or paper-specialty store for them.



- 4 Slide the paper adjusters so that they fit snugly against the edges of the envelope.

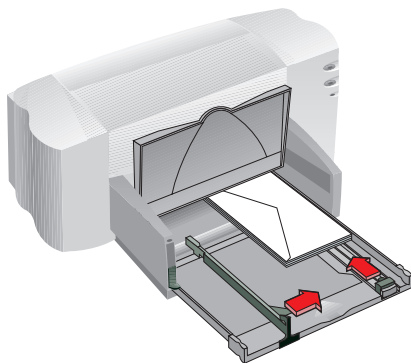

For small envelopes such as A2 or C6, you'll need to push the sliding adjuster in until it fits snugly against the edge of the envelopes.

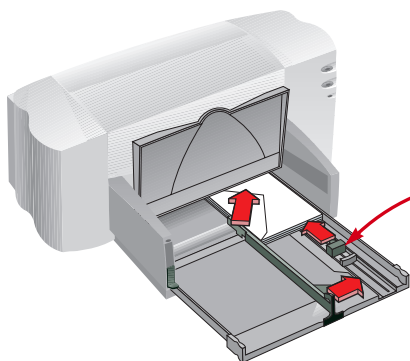

Push the sliding adjuster in.

- 5 Push the IN drawer back in and flip the OUT tray down.
- 6 Print the envelopes.

### AFTER PRINTING

- Change the paper size in the HP print settings box back to *Letter* or *A4* or to whatever you will be printing on next.
- Remove any remaining envelopes from the IN drawer and replace them with plain paper or whatever you'll be using next.

You can use your HP DeskJet printer to print sheets of labels. We recommend Avery Inkjet Labels, which are designed for your inkjet printer.

- 1 Click the *Setup* tab in the HP print settings box. Then select *Plain Paper* as the paper type and *Normal* as the print quality. (See page 9 for how to get to the HP print settings box.)

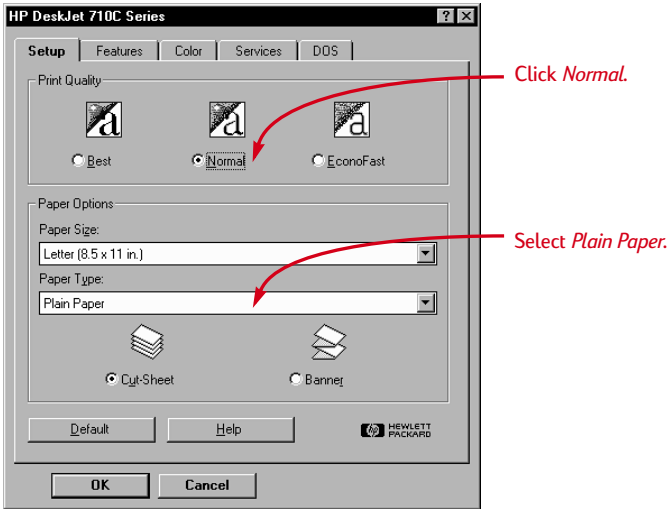

- 2 Fan the edges of the label sheets to separate them.



## Paper Pointers

### LABELS THAT WORK

Use only U.S. Letter or A4-sized sheets of labels. It's particularly important to pick labels that are made especially for inkjet printers. Otherwise, labels could peel off in your printer or the ink might not dry.

### LABELS THAT WON'T WORK

- Sheets of labels that are folded, curled, wrinkled, or partially used can get stuck in the printer.
- Old labels or labels that have gotten very hot might not stick well because the glue has deteriorated.



## Paper Pointers

### LABEL IT

When you're thinking about labels, why stop at envelopes or file folders? You can organize your media library by printing labels for videotapes, audio cassettes, and computer diskettes.

### SAVE ON LABELS

To save on label sheets, print a test on ordinary paper first. Then hold the paper up to the light on top of the labels to check the spacing and to see how the text aligns on the label. Make adjustments as needed.

### SHIP IT

Scan your logo in full color, and add it to your company address to print distinctive (and inexpensive!) labels for packages and manila envelopes. Avery makes both white and clear shipping labels for inkjet printers.

- 3 Remove all paper from the IN drawer and insert up to 20 label sheets.

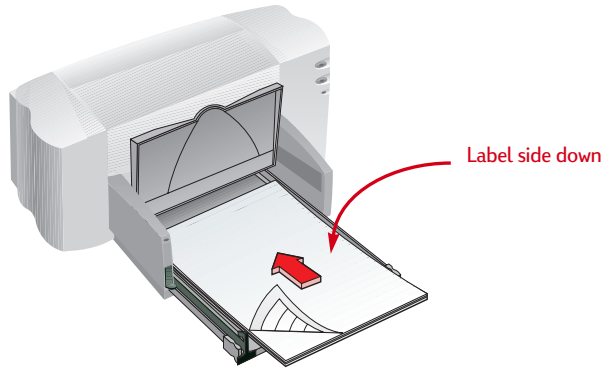

- 4 Slide the paper adjusters in to fit snugly against the stack.

- 5 Push the IN drawer back in and flip the OUT tray down.

- 6 Print the labels.

### AFTER PRINTING

- You can leave the settings as they are if you're going to be printing on plain paper.
- Remove the label sheets from the IN drawer and replace them with plain paper or whatever you'll be using next.



# Transparencies

For best results when printing your overhead presentation, use HP Premium Inkjet Transparency Film or transparencies specifically designed for inkjet printers.

- 1 In the HP print settings box, click the Setup tab. Select *HP Transparency* as the paper type, and click *Best* as the print quality. (See page 9 for how to get to the HP print settings box.)

It isn't absolutely necessary to use the *Best* print quality, but it'll give you the best results. If you're in a hurry, use *Normal* print quality.

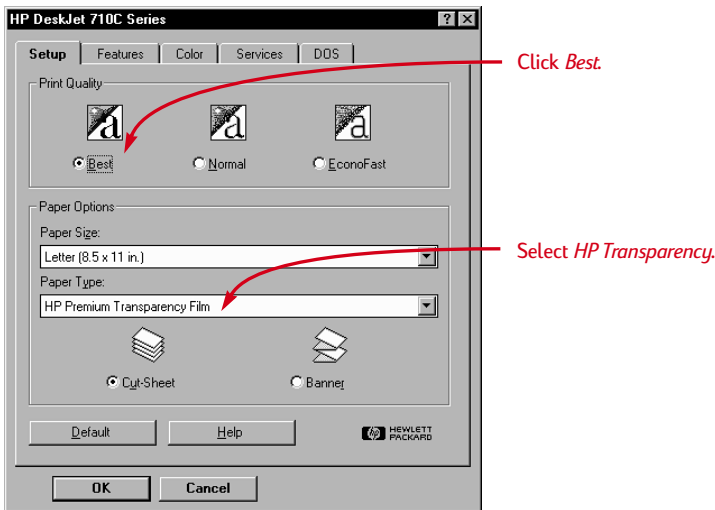

## Paper Pointers

### YOUR BEST BET

The film coating on HP Premium Inkjet Rapid-Dry Transparencies is especially developed to work with HP inks, giving you crisp images and text and the fastest drying time. In addition, they won't jam your printer. Look for them at any large office supply store, or call HP Direct (see page 62) for the phone number nearest you.



## What If

**THE INK NEVER DRIES OR THERE ARE CRACKS IN THE SOLID BLOCKS OF COLOR**



- You might have printed on the wrong side of the transparency. Make sure to put it into the printer rough side down.
- You might be trying to print on a transparency that wasn't meant for an inkjet printer.

**THE QUALITY ISN'T WHAT YOU WERE EXPECTING**

You might not have chosen the right paper type and print quality. Follow the steps in the procedure above, and try printing again.



## Handy Hints

**PROTECT YOUR TRANSPARENCIES**

If you want to make notes on your transparency as you talk, print the transparency as a flipped document (described on page 18).

- 2 Put the transparencies in your printer with the rough side down and the adhesive strip forward. (You can peel off the adhesive strip after printing.)

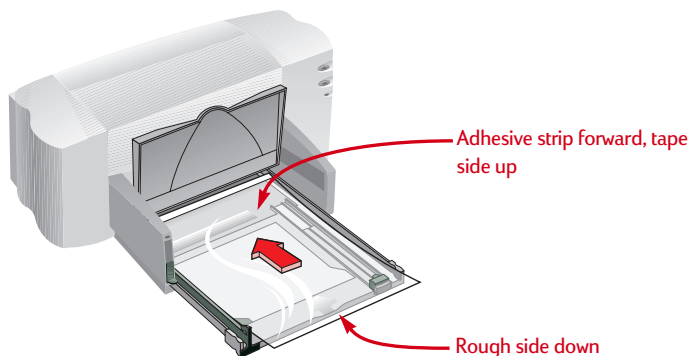

- 3 Slide in the paper adjusters, just as you would for plain paper. Push the IN drawer back in and flip the OUT tray down.
- 4 Print the transparency.
- 5 Be patient.

Because the printer uses more ink, lays the colors down more slowly, and allows for a longer drying time between sheets, transparencies take a while to print.

### **AFTER PRINTING**

- Change the paper type in the HP print settings box back to *Plain Paper* or to whatever is appropriate for what you'll be printing next.
- Remove any remaining transparencies from the IN drawer and replace them with plain paper or whatever you'll be using next.



# Photographs

For the best results, use HP Deluxe Photo Paper, HP Premium Photo Paper, or HP Photo Paper for exceptional quality photo images.

- 1 Click the *Setup* tab in the HP print settings box. Then select the type of photo paper you are using as the paper type. The print quality automatically changes to *Best*. (See page 9 for how to get to the HP print settings box.)

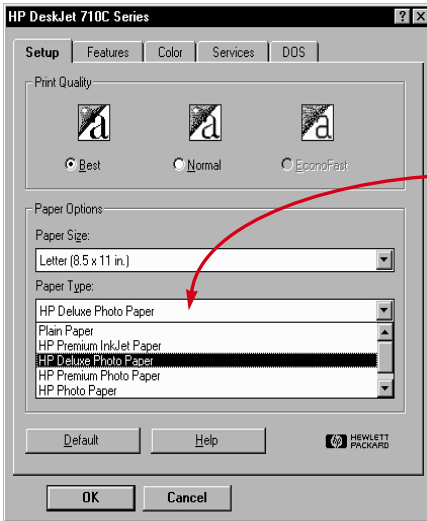

Select *HP Deluxe Photo Paper* or *HP Premium Photo Paper*.

- 2 Load the paper as you would for normal printing.

Make sure you insert the paper glossy-side down.

- 3 Print the document.

For the best results, remove each sheet promptly after printing, and allow it to dry glossy-side up. (The drying time will vary depending on the humidity.)

## AFTER PRINTING

- Change the paper type in the HP print settings box back to *Plain Paper* or to whatever is appropriate for what you will be printing on next.
- Remove the photo paper from the IN drawer and replace it with plain paper or whatever you'll be using next.



## Paper Pointers

### MAKE A GOOD IMPRESSION

Use HP Deluxe Photo Paper for best results when you're printing photographic images; its glossy surface provides crisp, vibrant images. When you select this paper in the HP print settings box, the printer uses Kodak Image Enhancements technology, which gives you excellent skintones and true-to-life landscape colors.

Use HP Premium Photo Paper to produce spectacular photos that look and feel like traditional photos.

Use HP Photo Paper for two-sided photo projects. Just print your photos on the glossy side and print your text and graphics on the matte side.



## Paper Pointers

### PRINTING NON-STANDARD CARDS

If the dimensions of your card aren't listed in the *Paper Size* box, select *Custom*. See page 14 for information about printing on different paper sizes.

### HOW THICK IS TOO THICK?

You'll find recommended media weights on page 57. If you want to use another weight card stock, give it a try.

### CARD STOCK

You can choose from literally hundreds of cards with preprinted designs for every occasion—you just add your own personal message. You'll also find letter-sized sheets of perforated business cards. Postcards come this way, too. Some of the cards have preprinted designs for added style.

### IF YOU WANT YOUR CARDS TO PRINT SIDEWAYS

Make sure the orientation of the page is *Landscape* in your software program. (The software program user's guide will tell you how.)



## Cards

Use your printer to print on index cards, recipe cards, postcards, business cards—any card size included in the *Paper Size* list on the *Setup* tab shown below. (You can print on other-sized cards, too, as described on page 14.)

- 1 In the HP print settings box, click the *Setup* tab, then select a card size in the *Paper Size* box. (See page 9 for how to get to the HP print settings box.)

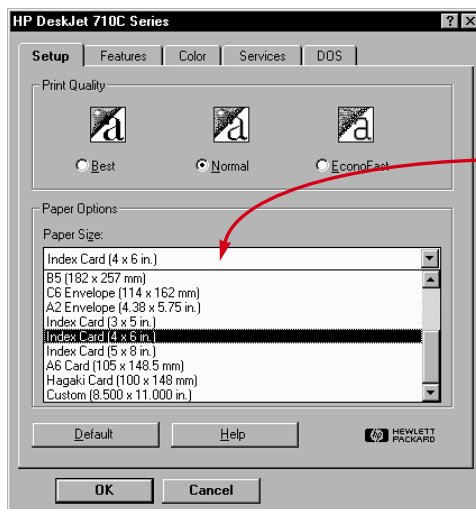

- 2 Slide out the IN drawer, slide out the paper adjusters, and flip up the OUT tray.
- 3 Place a stack of up to 30 cards (6 mm or 1/4 inch) in the drawer.

Make sure the orientation of the cards matches the orientation you've selected in your software program.

- 4 Slide the paper adjusters in so that they fit snugly against the cards.

Slide the paper-width adjuster to the right so that it holds the card stack snugly against the right edge of the IN drawer. If the cards are too small to be held securely by the paper-length adjuster, push the sliding adjuster in until it fits snugly against the edge of the stack.

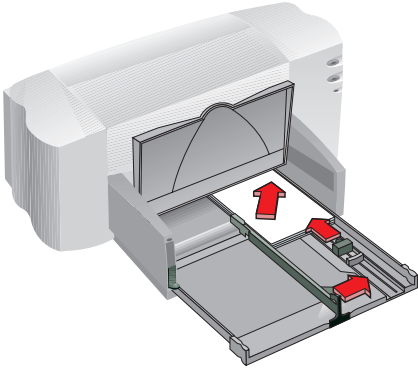

- 5 Push in the IN drawer and flip down the OUT tray.

- 6 Print the cards.

#### AFTER PRINTING

- Change the paper size in the HP print settings box back to *Letter* or *A4* or to whatever is appropriate for what you will be printing next.
- Remove any remaining cards from the IN drawer and replace them with plain paper or whatever you'll be using next.



## Paper Pointers

### MAKING FOLDED CARDS

HP makes a Greeting Card Paper with 20 blank white sheets and matching envelopes. Create your own design and message in a program that can format folded cards.

Make your own half-fold greeting cards that look and feel professional with HP Glossy Greeting Card Paper. Perfect for all your special occasions. The glossy finish is perfect for printing your favorite photos. Plus, they come with matching envelopes.

With HP Greeting Card Paper, printing personalized cards is easy. These smaller, quarter-fold cards are ideal for thank-you notes, invitations and birthday cards. The coated, matte-finish makes your graphics look great. They also come with matching envelopes.

Print following the directions for printing on regular paper on page 5. Then fold the paper into a card. Look for HP Greeting Card Paper at a large office or computer supply store, or call HP Direct (see page 62).





## Handy Hints

### FOLLOW YOUR SOFTWARE

The software program you're using might require special settings before it'll print banners correctly on your printer. Check out the banner information on either the *How do I?* tab or on the *Troubleshooting* tab in the HP Toolbox for information regarding your specific software program.



## Paper Pointers

### YOUR BEST BET

If you use HP Banner Paper, your banners will print with fewer paper jams and with brighter color and denser blacks. It's easy to use, too—you don't have to tear off those pesky perforated strips! Look for it at a large office supply store, or call HP Direct (see page 62).

### BANNER PAPER THAT WON'T WORK

Avoid coated paper—for example, paper that's colored on one side and not the other.



## Banners

We encourage you to use HP Banner Paper for the very best results. However, if you use computer or z-fold paper for your banners, we recommend that you use 20-pound or 75 g/m<sup>2</sup> paper. Always do a good job of fanning the paper before loading it.

- 1 In the HP print settings box, click the *Setup* tab and then click *Banner*. Then, in the *Paper Size* box, select *Letter* or *A4*. (See page 9 for how to get to the HP print settings box.)

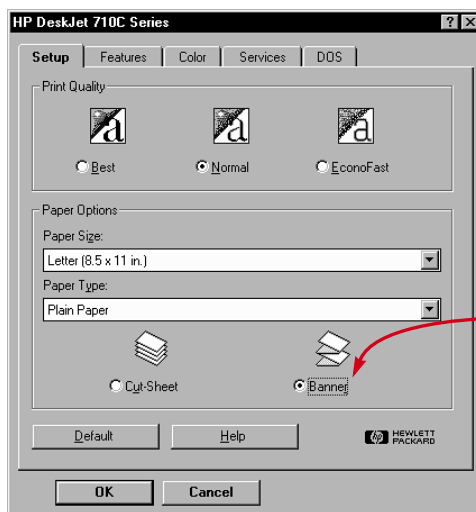

- 2 Flip the banner switch up.

The banner light goes on and the OUT tray lifts slightly, enabling the printer to pick up the banner paper.

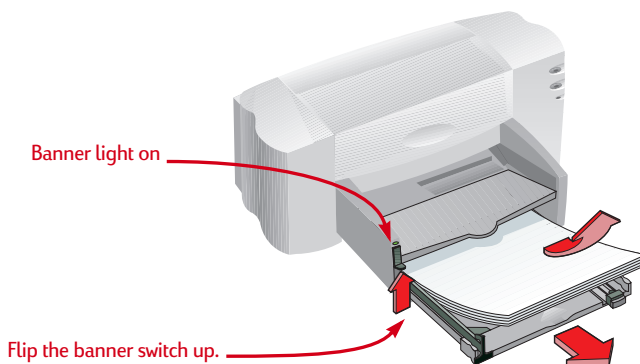

- 3 Remove all paper from the IN drawer.

**4** Get the banner paper ready for the printer:

- From the stack of banner paper, tear off the number of sheets you need to print the banner. (You must have at least five sheets in the stack.)
- Tear off the perforated strips, if there are any.
- Fan the stack so that the pages don't stick together in the printer.

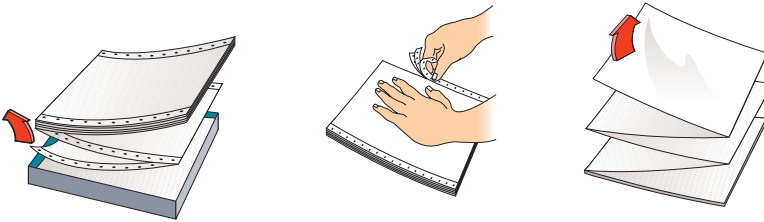

**5** Put the paper in the IN drawer so that the unattached edge is at the top of the stack. Insert the stack edge first into the IN drawer until it stops.

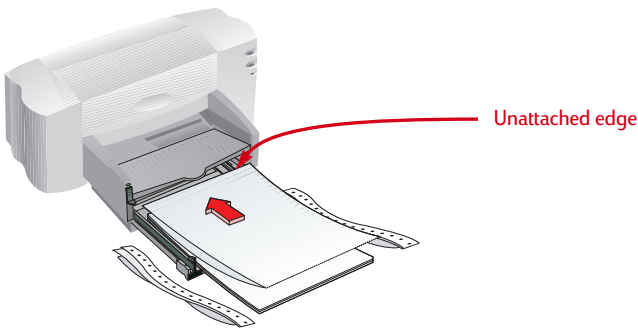

**6** Slide the paper adjusters so that they fit snugly against the edges of the paper stack.

**7** Push the IN drawer back in.

**8** Print the banner.

You'll notice that the printer and banner paper go through some start-up movements before it starts printing. Also, banner printing takes a while; it might be several minutes before you see the results.



## What If

### THE BANNER HAS A BIG GAP OR A CREASE WHERE YOU DON'T EXPECT IT

The printer might be picking up more than one sheet of paper at a time. Take the paper out, then fan the stack. Also be sure the top and bottom margins are set to zero in your banner program. Print the banner again.

### THE BANNER PAPER JAMS IN THE PRINTER

- You might not have clicked *Banner* on the *Setup* tab in the HP print settings box.
- Try putting in more than five, but fewer than 20, sheets of paper.
- Make sure the banner switch is up.
- See the online troubleshooting for the appropriate settings for specific software programs.
- Make sure you remove all paper before loading the banner paper.



## What If

### YOU GET A MESSAGE THAT SAYS YOU'RE OUT OF PAPER, BUT YOU'RE NOT

You might not have pushed the paper-length adjuster in all the way. Make sure it's snug against the paper, and try printing again.

### THE TEXT IS FUZZY AFTER PRINTING A BANNER

If the print quality seems especially poor when you switch from banner printing, you might have forgotten to reset the printer for normal printing.

- 9 After your banner is printed, if the Resume light is blinking, press the Resume button as many times as needed until all the banner paper is out of the printer.

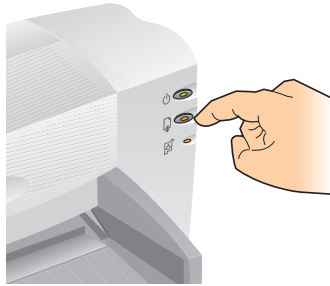

Resume button

#### AFTER PRINTING

- Click *Cut-Sheet* in the HP print settings box.
- Flip the banner switch down so that the light goes off.
- Put paper in the IN drawer.

# Iron-On Transfers

When it comes to printing images, you don't need to stop with paper. Use transfer paper to get the images from the computer document onto cloth. You'll need:

- the t-shirt or other cloth you want to transfer an image onto
- the document containing the picture or text you want to print
- iron-on transfer paper, which you can buy at a computer or office supply store

## Here's how you do it

- 1** On your computer, open the document containing the text or picture you want to transfer to the t-shirt.
- 2** In the HP print settings box, click the *Setup* tab. Select *HP Premium Inkjet Paper* as the paper type.
- 3** If you want the text or picture on your t-shirt as you see it on the screen, flip the document by clicking *Flip Horizontal* on the *Features* tab.
- 4** Load the transfer paper transparent-side down in the printer.
- 5** Print the transfer.
- 6** Follow the instructions included with the iron-on transfer paper to transfer the image onto your shirt.

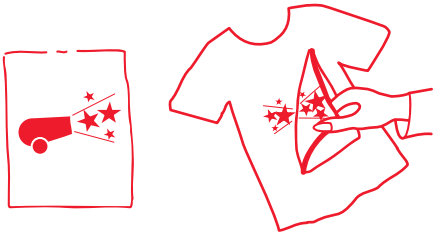

## **AFTER PRINTING**

- Click the *Flip Horizontal* box in the print settings box to clear it.
- Replace the transfer paper with your everyday paper.



## Paper Pointers

### BEYOND T-SHIRTS

Although 100% cotton t-shirts are a popular choice for iron-on transfers, you need not stop there. Transfer a photo onto an apron, or add the company logo to baseball caps, sun visors, and tote bags for the company picnic.



### WORKING TOGETHER

HP Iron-On T-Shirt Transfers are designed to work with your printer and HP ink to give you a professional silk screen look.

# Getting Help When Things Go Wrong

Online  
Troubleshooting

Common  
Problems

Printer  
Communications

Buttons &  
Lights

HP Customer  
Care

**W**hen problems occur, the quickest way to find a solution is to use the online troubleshooting feature. With a few clicks of the mouse button, you'll find your specific problem and details on how to fix it.

## Click your way to a solution

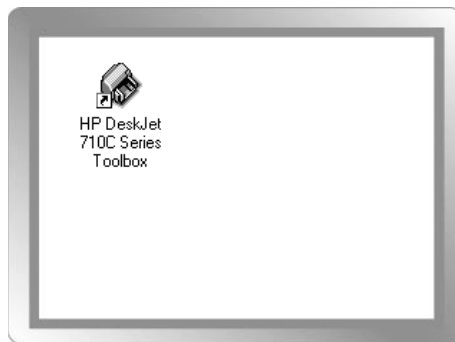

- 1** Double-click the Toolbox shortcut (or icon) on your desktop first. (See page 11 if you can't find the HP Toolbox.)

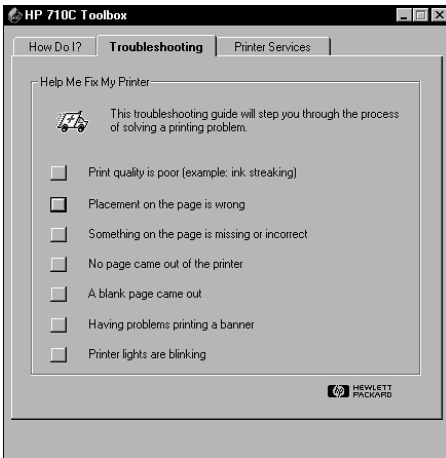

2 Click the *Troubleshooting* Tab.

3 Click the appropriate category. (The following pages include an overview of common problems in each category.)

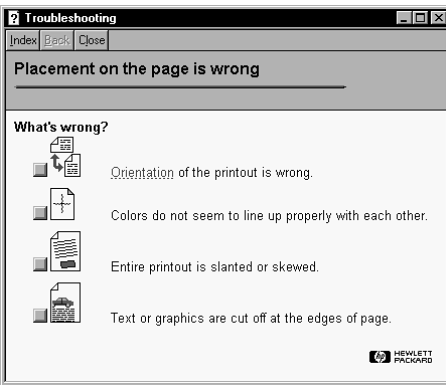

4 What seems to be the problem?

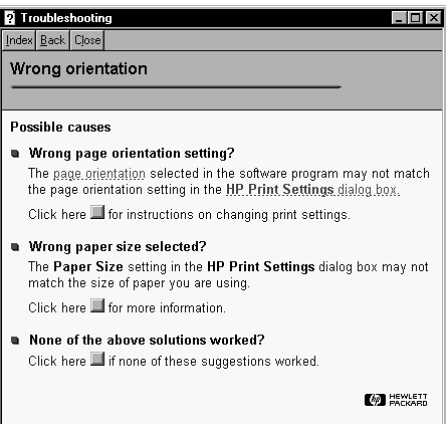

5 Explore the possibilities.



## What If

If the print cartridge light  continues to blink after you install new cartridges, check the part numbers on the cartridges.

- Black HP 51645G

- Large Black HP 51645A

- Tri-Color HP C1823A

## What if?

### No page came out of the printer

**Be patient.** Complex documents, such as color photographs, take awhile to print. Check the Power  light; if it's blinking, the printer is processing information.

**Power.** Make sure the printer is on (the Power  light on the front of your printer should be on) and that all connections are firm.

**Cover.** Make sure the top cover of the printer is closed.

**Paper.** Make sure you put paper in the IN drawer correctly.

**Communications.** If you see a “Printer Not Responding” message on your screen, you might be using the wrong cable. (The bidirectional HP IEEE-1284-compliant Parallel Interface Cable is recommended.)

**Print cartridges.** Make sure both print cartridge cradles contain properly installed cartridges with the correct part number.

**Paper Jam.** Make sure no paper is stuck in the printer. See page 6 for more information.

 CHECK ONLINE TROUBLESHOOTING FOR MORE HELP.

### A blank page came out of the printer

**Tape.** Make sure you've removed the protective pieces of tape on the print cartridges.

**Default printer.** Make sure you've selected the HP DeskJet 710C Series printer as the default printer. To check your default printer, click the *Troubleshooting* tab in the HP Toolbox, and then click *A blank page came out*. Under *Wrong printer* selected, click the button for complete instructions on setting a default printer and follow the steps on your screen.

**Ink.** You might have run out of ink. Replace the cartridges as shown in step 4 of the setup guide.

**Faxes.** If you've received an electronic fax at your computer and the printer prints a blank page when you try to print the fax, try saving the fax in a graphic format (such as TIF). Then place it in a word-processing document, and print from there. Alternatively, see online troubleshooting for the solution.

 CHECK ONLINE TROUBLESHOOTING FOR MORE HELP.

### The text or graphics are in the wrong place

**Paper orientation.** If the printing is positioned incorrectly on the page, make sure you've selected the correct orientation (*Portrait* or *Landscape*) on the Features tab of the HP print settings box.

**Alignment.** If the color ink and black ink don't line up on the printed page, you might need to align the print cartridges. In the HP Toolbox, click the *Printer Services* tab, and then click *Align the print cartridges*.

**Loading.** If the printing is slanted or skewed, try reloading the paper and make sure the rear access door is properly locked, as described on page 6.

**Margin settings.** If text is running off the edge of the page:

- Make sure the margins are set correctly in your software program.
- Make sure the elements in your document fit within the printable area of the page (see page 57.)
- Make sure you've selected the right paper size on the *Setup* tab of the HP print settings box.

 CHECK ONLINE TROUBLESHOOTING FOR MORE HELP.

## The print quality is poor

**Banner switch.** Make sure the banner switch is down, unless you're printing banners.

**Paper.** If the printing is faded or the colors are dull or bleeding into each other, make sure you're using paper intended for inkjet printers, that the correct paper setting is chosen in the software, and that you've loaded the paper print side down.

**Cartridges.** If ink is smearing or is blotchy:

- You might need to clean the ink cartridges. In the HP Toolbox, click the *Printer Services* tab, and then click *Clean the print cartridges*.
- You might need to replace the ink cartridges, as described in step 4 of the setup guide.

## Something on the page is wrong or missing

**Margin settings.** If the printing is cut off around the edges, check your software program to make sure that:

- The margins are set correctly.
- The elements are scaled correctly.

**Colors.** If the colors are wrong or missing:

- You might need to clean your color print cartridge. In the Toolbox, click the *Printer Services* tab, and then click *Clean the print cartridges*.
- You might need to replace the color ink cartridge, as described in step 4 of the setup guide.

## You're having trouble printing a banner

**Print settings.** If you haven't selected the correct print setting, you'll get a paper mismatch error message. Cancel the job and make sure you've clicked *Banner* on the *Setup* tab of the HP print settings box. Resend your job to the printer.

**Banner switch.** If the paper jams, make sure you've pushed the banner switch up and inserted the banner paper all the way into the IN drawer.

**Loading.** If several sheets feed into the printer together, try unfolding and folding the paper to get more air between the sheets.

 FOR DIRECTIONS TO ONLINE TROUBLESHOOTING SEE PAGE 40-41.

**Ink.** You can control the amount of ink on the page by changing the print quality (on the *Setup* tab of the HP print settings box).

- If the printing appears faded or the colors are dull, click *Normal* or *Best* instead of *EconoFast*.
- If the colors bleed into one another or the ink smears on the sheet, click *Normal* or *EconoFast* instead of *Best*.
- You might be running out of ink. Replace the cartridges as explained in step 4 of the setup guide.

 CHECK ONLINE TROUBLESHOOTING FOR MORE HELP.

- Make sure you haven't selected *Print in Grayscale* on the *Setup* tab of the HP print settings box.

**Communications.** If meaningless characters are printing on your page, the computer might have lost communication with your printer. Make sure all cables are plugged in tightly. Make sure you're using a bidirectional cable. To test the cable, in the HP Toolbox, click the *Printer Services* tab, and then click *Test the printer communication*.

 CHECK ONLINE TROUBLESHOOTING FOR MORE HELP.

**Paper.** If the paper creases as it passes through the printer, the paper might be inappropriate for banner printing. HP Banner Paper is highly recommended.

**Margin gap.** If you see gaps in the printing at the ends of the sheets, a problem might exist in your software program. See online troubleshooting for more information.

 CHECK ONLINE TROUBLESHOOTING FOR MORE HELP.



# Printer Communications

Your printer does not include a printer cable. The HP IEEE-1284-compliant Parallel Interface Cable is best for your printer. Make sure the cable is bidirectional—that is, that it allows two-way communication between your printer and the computer. This type of cable allows you access to all your printer's features.

If you don't know whether your printer cable is bidirectional, you can find out by following these steps:

- 1** Make sure the printer cable is securely connected to both the printer and the computer.
- 2** Make sure both the printer and the computer are turned on.
- 3** Click the *Printer Services* tab of the HP Toolbox.
- 4** Click *Test printer communication*.

The printer software tests the communication between your computer and your printer and tells you if you have bidirectional communications.



If the cable is bidirectional, you should have access to all the features of your HP DeskJet printer.

If the cable is not bidirectional, the printer might be unable to send messages to the computer screen, but the printer will still be able to print.

At the time of publication, bidirectional communication was not available in Windows NT 4.0.

## Buttons and Lights

There are two buttons and three lights on the front of the printer. The lights indicate when the printer is operating correctly or when it needs attention from you. The buttons are used to control the printer.

- |   |  |
|---|--|
|  Power Button and Light  | When lit the light indicates that the printer is turned on.  |
|  Resume Button and Light | Light blinks when there is a problem concerning paper. Correct the problem and press the button.   |
|  Print Cartridge Light   | Blinks when there is a problem concerning a print cartridge. Correct the problem. When the problem is corrected and the top cover is closed, the light will stop blinking. |

If two or more lights blink at the same time, there is a printer problem. Correct the problem and turn the printer off then back on again. See the *Troubleshooting* tab of the HP Toolbox for solutions.

# HP Customer Care

If you have questions, either general ones regarding how your printer works or specific ones regarding a problem you're having, you have several possibilities for getting the answers.

## Troubleshooting Using the Toolbox

If you have a specific problem, the quickest way to find a solution might be right at your fingertips. Check the online troubleshooting feature, located in the HP Toolbox. (See page 11 to find out how to get to the Toolbox.) If the suggestions in the Toolbox don't solve your problem, you still have many options, as described in the following paragraphs.

## Electronic Support Information

If you have a modem connected to your computer and subscribe to an online service or have direct access to the Internet, you can obtain a wide variety of information about your printer:

### User Forums

You can get friendly help from knowledgeable users and system operators in the HP Customer Care Web site, CompuServe (Go HPPER) and America Online (keyword: HP) user forums. In the user forums, you can leave your question and check back later for ideas and solutions suggested by other users. You can read through old messages left by other users to see if anyone else has had a problem similar to yours and has provided the solution online.

### HP Customer Care Web Site

If you have access to the Internet, you can check out the HP Customer Care Web site at <http://www.hp.com/go/support> for the latest support documentation, software, and news from HP.

## Printer Software

Printer software (also referred to as a printer driver) allows your printer to talk with your computer. HP provides printer software and software upgrades for Windows and Windows NT 4.0. For DOS printer software, contact the manufacturer of your software program. You have several options for getting software.

- Download the driver by accessing the HP Customer Care Web site, CompuServe, or America Online.
- If you are in the U.S., setting up your printer for the first time, and do not have a CD-ROM drive, you can order the software on 3 1/2" disks by calling the toll free phone number listed on the printer software CD case. Disks will be delivered to you the next day for no charge.
- If you are in the U. S. and need a software upgrade you can order by calling 1-805-257-5565. Software upgrades are available for the cost of the disks plus shipping.
- If you are outside the U.S. call your nearest HP Customer Care Center.



## Handy Hints

### USER FORUMS

Both forums keep a list of FAQs (Frequently Asked Questions) which you can peruse for hints.

**CompuServe:** Access the HP Peripherals forum (Go HPPER).

**America Online:** Access the HP forum. Click "keyword" on the "Go To" menu, type "HP," and press the ENTER key to bring the HP forum home page directly to your screen.

### HP CUSTOMER CARE REPAIR

To speak to someone to verify that your printer needs repair, please call the HP Customer Care Center. If your printer requires repair, the HP Customer Care service technician will coordinate the process. This service is free of charge during the warranty period of your printer. Beyond the warranty period, repairs will be charged on a time and materials basis.

## FREE SUPPORT FOR NINETY DAYS

Within 90 days from the time of your purchase, telephone support is provided to you free of charge. Before placing a call for help, please make sure that:

- you have checked your user's manual and online troubleshooting for installation troubleshooting tips
- you are seated in front of your computer, with your printer nearby
- you have the following information available:
  - your printer's serial number (the label is on the back of the printer)
  - your printer's model number (the label is on the front of the printer)
  - the model of the computer
  - the version of the printer driver and software application (if applicable)

### A NOTE ABOUT LETTERS

If you need technical help from a technical support person, we recommend that you call us while you're in front of your computer and printer, rather than writing a letter to us. That way we can help you with your questions immediately!

## HP Customer Care By Phone

To speak with someone for online technical assistance, call one of the following numbers. This service is free during the warranty period of your printer. However, if you are calling long distance, the usual long-distance charges apply.

■ Africa/Middle East	41 22/780 71 11
■ Argentina	541781-4061/69
■ Australia	61 3 92728000
■ Austria	43 (0)660 6386
■ Belgium (Dutch)	32 (0)2 62688 06
■ Belgium (French)	32 (0)2 6268807
■ Brazil	55 11 709-1444
■ Canada (English)	(208) 344-4131
■ Canada (French)	(905) 206-4383
■ China	86 10 6505 3888-5959
■ Czech Republic	42 (2) 471 7321
■ Denmark	45 (0)39 294099
■ Finland	385 (0)203 47288
■ France	33 (0) 143623434
■ German	49 (0) 180 5258 143
■ Greece	30 1 689 64 11
■ Hong Kong	(800) 96 7729
■ Hungary	36 (1) 252 4505
■ India	91 11 682 60 35
■ Indonesia	6221 350 3408
■ Ireland	353 (0) 1662 5525
■ Italy	39 (0)2 264 10350
■ Japan, Tokyo	81 3 3335-8333
■ Japan, Osaka	81 6 838 1155
■ Korea	82 2 3270 0700
■ Malaysia	03 2952566
■ Mexico D.F.	326 46 00
■ Mexico, Guadalajara	669 95 00
■ Mexico, Monterey	378 42 40
■ Middle East/Africa	41 22/780 71 11
■ Netherlands	31 (0)20 606 8751
■ New Zealand	(09) 356-6640
■ Norway	47 (0)22 116299
■ Philippines	65 272 5300
■ Poland	48 22 37 50 65
■ Portugal	351 (0) 144 17 199
■ Russia	7095 923 50 01
■ Singapore	65 272 5300
■ Spain	34 (9) 02321 123
■ Sweden	46 (0)8 6192170
■ Switzerland	41 (0)84 8801111
■ Taiwan	886 2-2717-0055
■ Thailand	(66-2) 661 4011
■ Turkey	90 1 224 59 25
■ United Kingdom	44 (0) 171 512 5202
■ U. S.	(208) 344-4131
■ Venezuela	58 2 239 5664

## After the Warranty

You can still get help from HP for a fee. Prices are subject to change without notice. (Online help is still available for free!)

- For quick questions in the United States only, call (900) 555-1500. The charges are \$2.50 per minute and begin when you connect with a support technician.
- For calls from Canada, or for calls in the U.S. that you anticipate might be longer than ten minutes in length, call (800) 999-1148. The fee is US \$25 per call, charged to your Visa or MasterCard.
- If during your phone call, it is determined that your printer requires repair, and you are within your printer's hardware warranty period, your phone charges will be reversed.

# More About Your Printer

System Requirements

Print cartridges

Uninstalling the Software

Printing from DOS

Minimum Printing Margins

Specifications

Additional Symbol Sets & Fonts

Ordering Supplies & Accessories

Ordering Information

Regulatory Notices

Warranty Statement

**U**ntil now, we've been talking about the what, where, and how of your printer. If you're ready for some simple facts about the printer and printer supplies, here they are.

## System Requirements

- Microsoft Windows 3.1x, Windows 95, Windows 98, or Windows NT 4.0
- **System Requirements:**

Windows 3.1x, Windows 95, and Windows 98	Windows NT 4.0
- 80486/66 MHz CPU	- Pentium CPU
- 8 MB of RAM (16 Recommended)	- 16 MB of RAM (32 Recommended)
- Allows MS-DOS® printing through Windows 3.1x, Windows 95, and Windows 98
- Network printing not supported

**NOTE** *The HP DeskJet 710C Series printer is a personal printer for Windows®.*

## A Word about Windows NT 4.0

At the time of publication these features were not available in the Windows NT 4.0 environment:

- Bidirectional communications
- Printing from MS-DOS

# Print cartridges

To get the best performance from your printer, Hewlett-Packard recommends using only genuine HP supplies in HP inkjet printers, including only HP print cartridges. Damage resulting from the modification or refilling of HP cartridges is specifically excluded from coverage of HP printer warranties.

Refilling an HP cartridge pushes the electronic and mechanical components of the cartridge past their normal life cycle, creating many potential problems, such as the following:

## Poor print quality

- Non-HP ink can contain components that cause nozzles to become clogged, resulting in streaked copy and graying or fuzzy characters.
- Non-HP inks can contain components that corrode the cartridge's electrical components, resulting in poor printouts.

## Potential damage

- If ink from a refilled cartridge leaks, the excess ink might damage the service station that caps the cartridge while it is in the printer but not in use. Because this service station maintains the health of the cartridge, quality problems might occur with this cartridge.
- If ink from a refilled cartridge leaks onto the electrical components in your printer, severe printer damage can occur, causing down-time and repair costs.

**CAUTION** Damage resulting from the modification or refilling of HP cartridges is specifically excluded from the coverage of HP printer warranties.

**NOTE** When buying replacement print cartridges, check the part numbers carefully so that you buy the right cartridges for your printer:



Black  
HP 51645G



Large Black  
HP 51645A



Tri-Color  
HP C1823A

# Storing and using print cartridges

To maintain excellent print quality from your print cartridges:

- Keep all print cartridges in their sealed packages, at room temperature (60-75° F or 15.6-26.6° C), until you are ready to use them.
- Turn off the printer and allow the print cartridges to return to the right side of the printer for proper capping of the nozzles before you unplug the power module or turn off any attached power strip.

**NOTE** When either the black or tri-color print cartridge runs out of ink, replace it. If you do not have a new print cartridge, leave the empty print cartridge in the cradle until you can replace it. The printer cannot print with only one print cartridge installed.

**CAUTION** The ink in the print cartridges has been carefully formulated by Hewlett-Packard to ensure superior print quality and compatibility with the printer. Do not attempt to refill a print cartridge; damage to the printer or to the print cartridge resulting from modifying or refilling a print cartridge is not the responsibility of Hewlett-Packard.

To install the print cartridges in your printer, follow the procedure *Insert the Print Cartridges* in your Setup Guide.

If the print cartridge  light continues to blink after you install new print cartridges, check the part numbers on the cartridges.

**NOTE** *Be careful not to touch the ink nozzles or the copper contacts. This could result in clogs or bad electrical connections.*

## Removing print cartridges

**1** With the printer turned on, open the top cover.

In a few moments the print cartridge cradles automatically move to the center of the printer and the print cartridge  light flashes.

**2** Snap up the cradle latch from the top of the print cartridge to be replaced.

**3** Lift the print cartridge out of the cradle.

**4** Discard the used print cartridge.

**WARNING** *Keep new and used print cartridges out of the reach of children.*

## Aligning the print cartridges

You must align the black and tri-color print cartridges each time you replace or reinstall a print cartridge. This ensures that the black and tri-color inks are aligned when used together on the same line of text or within the same picture. Refer to the Setup Guide for procedures.

DOS users can align the print cartridges from the HP DeskJet Control Panel for DOS. Refer to “Printing from DOS” on page 56 for details.

# Cleaning the print cartridges

Cleaning your print cartridges can improve the quality of printing.

If your printed page is missing lines or dots, perform Procedure 1 below. If your printed page contains streaked ink, perform Procedure 2.

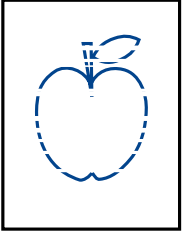

## Procedure 1: Correcting missing lines or dots

Clean the print cartridges when you notice that the lines or dots are missing from your printed text and graphics, as shown on the left. The print cartridges can be cleaned from the HP Toolbox.

**NOTE** Do not clean the print cartridges unnecessarily, as this wastes ink and shortens the life of the print cartridge.

**NOTE** DOS users can clean the print cartridges from the HP DeskJet Control Panel for DOS. Refer to "Printing from DOS" on page 56 for details.

### To clean the print cartridges from the HP Toolbox:

- 1 Double-click the HP Toolbox icon on the computer screen.
- 2 Click the *Printer Services* tab.

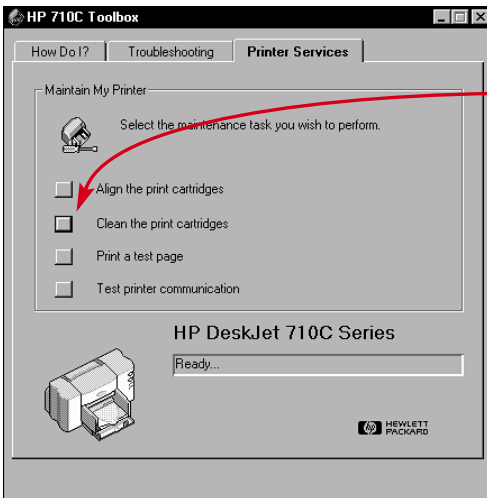

Click here to clean print cartridges



- 3** Click *Clean the Print Cartridges* and follow the directions on the screen.

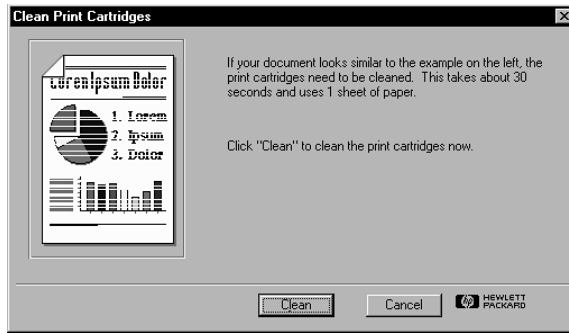

If the print quality improves by going through this sequence once, but the quality is still not quite good enough, try going through the procedure again. Start at step 1, or click on the “Intermediate Clean” button on the last cleaning window. There is no harm done but a little wasted time and ink.

But if these steps do not improve the print quality, your print cartridges might be low on ink. Replace the print cartridges.

Also, dust fibers occasionally drag through the wet ink and streak it. If problems persist, continue to Procedure 2.

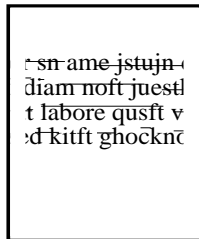

## Procedure 2: Eliminating ink streaks

Customers using HP DeskJet printers in dusty environments might occasionally experience ink streaks because of a small accumulation of debris inside the printer. This debris can include dust, hair, carpet, or clothing fibers. Ink streaking is easily prevented or corrected by cleaning two areas of the printer: the print cartridges and the print cartridge cradle.

## Materials you will need to clean your printer

Before you begin, make sure you have the following materials available:

- Cotton swabs or any soft material that will not come apart or leave fibers (for example, a piece of clean cotton cloth).
- Distilled, filtered, or bottled water (tap water might contain contaminants that can damage the print cartridges).
- Scrap paper or paper towels to set the print cartridges on while you are working.

**CAUTION** Be careful not to get ink on your hands or clothing.

## Steps to clean your printer

### 1 Remove the print cartridges

- Turn the printer **on** and lift the printer's top cover.  
The print cartridges move to the center of the printer.
- After the print cartridges have moved to the center of the printer, **unplug** the power cord from the back of the printer.
- Remove the print cartridges and place them on their sides on a scrap piece of paper.

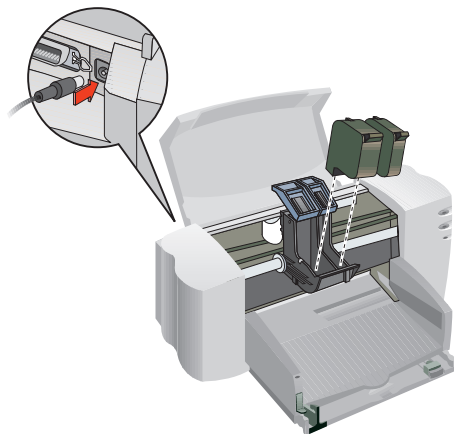

**WARNING** Keep new and used print cartridges out of the reach of children.

**CAUTION** Once you've removed the print cartridges, make sure that they are not outside of the printer for more than 30 minutes.

### 2 Clean the print cartridges

- Dip a clean cotton swab into distilled water and **squeeze** any excess water from the swab.
- Grasp the black print cartridge by the top.
- Clean the **face** and **edges** of the print cartridge as shown. **DO NOT** wipe the nozzle plate.

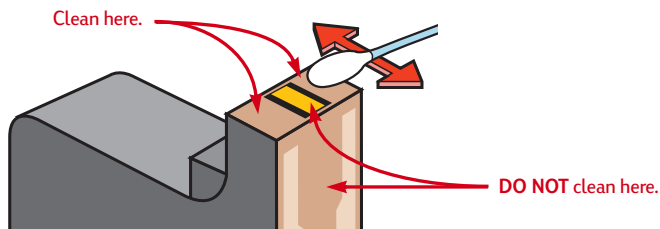

- d. Hold the print cartridge up to the light to inspect for fibers on the face and edges. If fibers are still present, repeat steps 2b and 2c.
- e. Repeat steps 2a through 2d with the other print cartridge using a clean, moistened cotton swab to avoid any contamination.

### 3 Clean the print cartridge cradle

- a. Position yourself at eye level with the printer.
- b. Locate the cradle that holds the print cartridges.
- c. Using clean, moistened swabs, wipe the underside of each wall of the carriage where fibers may collect and come in contact with the paper. Repeat until no ink residue is seen on a clean swab.

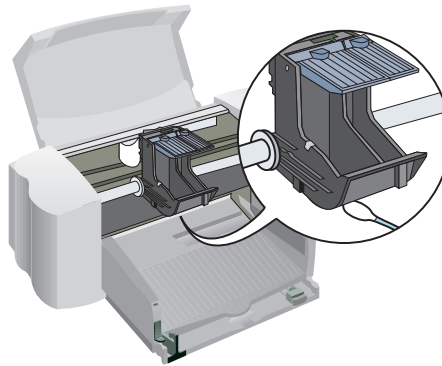

### 4 Reinstall the print cartridges

- a. Reinstall the print cartridges and close the printer's top cover.
- b. Reinsert the power cord into the back of the printer.
- c. Go to the *Printer Services* tab of the HP Toolbox and click *Print a self-test page*.
- d. Examine the printout for ink streaking.

**NOTE** *This procedure should remove all fibers that would cause ink to streak on a printout. However, fibers can be missed. If the printout still shows streaking, repeat the procedure until the test printout is clear and sharp. This procedure and additional maintenance tips are located on the HP Customer Care Web site at <http://www.deskjet-support.com/maintenance>.*

## Uninstalling the software

If you need to uninstall the printer driver for your HP DeskJet printer for any reason, perform one of the steps listed for your operating system. If something unexpected happened during installation, the safest method is to run the uninstall utility directly from the CD or disks rather than from the uninstall program that was placed on your hard drive.

### For Windows 3.1x, do *one of the following*:

- In Program Manager, locate your HP DeskJet Series group. Double-click the *Uninstall* icon to uninstall your printer software.

OR

- Insert the driver disk (either driver disk #1 or your CD) into your computer and run Setup.exe. Select the third option to “Remove the HP DeskJet 710C Series software from your PC.”

### For Windows 95, Windows 98, and Windows NT 4.0, do *one of the following*:

- From the *Start* menu, click *Programs*, click *HP DeskJet 710C Series*, and then *HP DeskJet 710C Series Uninstaller*.

OR

- From the *Start* menu, click *Settings*, click *Control Panel*, and then *Add/Remove Programs*. Select *HP DeskJet 710C Series (Remove only)*.

OR

- Insert the driver disk (either driver disk #1 or your CD) into your computer and run Setup.exe. Select the third option to “Remove the HP DeskJet 710C Series software from your PC.”

# Printing from DOS

While your HP DeskJet printer is primarily a Windows printer, you can also print from a DOS software program when you run the program within Windows 3.1x, Windows 95, or Windows 98. At the time of publication this capability was not available in the Windows NT 4.0 environment.

## To print from DOS:

- 1 Ensure the HP DeskJet 710C Series printer driver is set as the default in Windows.
- 2 Run the DOS application within Windows.
- 3 In the DOS application, select *DeskJet 660C* or *DeskJet 550C* as the printer. (You might need a driver for this, which you can obtain from the software vendor.)
- 4 Print the document.

The print settings available for printing from DOS are located on the *DOS* tab of the HP print settings box. Settings located on the other tabs of the box will not affect printing from DOS.

To ensure proper DOS printing from Windows 95 and Windows 98, do not rename the printer icon in the Printer folder. Verify the following settings:

- From the *Details* tab of the HP print settings box, select *Spool Settings*. Ensure that “Enable bidirectional support for this printer” is selected.
- From the *Details* tab of the HP print settings box, select *Port Settings*. Ensure that “Spool MS-DOS print jobs” is selected, and “Check port state before printing” is NOT selected.

The following settings are available:

- **Paper Size.** Select the appropriate paper size in the *Paper Size* box.
- **Character Set.** Select the appropriate internal character set (emulated) in the *Character Set* box.
- **Form Feed.** Tell the printer how much time, in seconds, it should wait after receiving the last batch of data before it ejects the paper. Either type the number of seconds in the *Seconds* box or click the up or down arrow to select a number.

\* **To get to the HP print settings dialog box in Windows 95 or Windows 98:** In the task bar, click Start. Point to *Settings* and then click *Printers*. Highlight the *HP DeskJet 710C Series* printer icon in the *Printers* box. From the *File* menu, choose *Properties* to display the HP print settings box.

**To get to the HP print settings dialog box in Windows 3.1x:** In the *Program Manager*, double-click the *Control Panel* icon. In the *Control Panel*, double-click *Printers*. In the *Printers* box, highlight *HP DeskJet 710C Series* and click the *Setup* button to display the HP print settings box.

# Minimum printing margins

The printer cannot print outside a certain area of the page, so you must make sure the contents of your document fall within the printable area—that is, within the top, bottom, left, and right margins available for the specific size paper on which you are printing.

When you use nonstandard paper sizes and select the *Custom Paper Size* setting in the HP print settings box, the paper width must be between 3 and 8.5 inches (77 and 215 mm) and the paper length must be between 3 and 14 inches (77 and 356 mm).

Paper Size	Left/Right Margins	Bottom Margin
U.S. Letter 8.5 x 11 in	0.25 in	0.46 in
U.S. letter banner 8.5 x 11 in	0.25 in	0.00 in
U.S. legal 8.5 x 14 in	0.25 in	0.46 in
A4 size 210 x 297 mm	3.2 mm	11.7 mm
A4 banner 210 x 297 mm	3.2 mm	0.00 mm
A5 size 148 x 210 mm	3.2 mm	11.7 mm
B5 size 182 x 257 mm	3.2 mm	11.7 mm
Executive 7.25 x 10.5 in	0.25 in	0.46 in
U.S. cards 4 x 6 in	0.125 in	0.46 in
U.S. cards 3 x 5 in	0.125 in	0.46 in
U.S. cards 5 x 8 in	0.125 in	0.46 in
A6 cards 105 x 148 mm	3.2 mm	11.7 mm
Hagaki postcards 100 x 148 mm	3.2 mm	11.7 mm

*Note: The top margin is 1 mm (0.04 in) for all paper sizes (except for banner paper).*

Envelope Size	Left Margin	Right Margin
U.S. No. 10 4.12 x 9.5 in	0.04 in	0.46 in
DL 220 x 110 mm	1 mm	11.7 mm
C6 114 x 162 mm	1 mm	11.7 mm

*Note: The top and bottom margins are 3.2 mm (0.125 in) for all envelope sizes.*

**NOTE** DOS margins can vary. See the manual for the specific DOS program for more information.

# Specifications

## Printers

HP DeskJet 710C printer model number C5894A  
HP DeskJet 712C printer model number C5894B

## Print technology

Drop-on-demand thermal inkjet printing

## Black print speed \*

EconoFast: 6 pages per minute  
Normal mode: 4 pages per minute  
Best mode: 4 pages per minute

## Color print speed (mixed text and graphics) \*

EconoFast: 3 pages per minute  
Normal mode: 1 pages per minute  
Best mode: 0.5 pages per minute

## Color print speed (full page color) \*

EconoFast: 1 pages per minute  
Normal mode: 0.3 pages per minute  
Best mode: 0.2 pages per minute

## Black resolution \*\*

EconoFast: 300 x 300 dpi  
Normal mode: 600 x 600 dpi  
Best mode: 600 x 600 dpi

## Color resolution (depends on paper type) \*\*

EconoFast: 300 x 300 dpi  
Normal mode: 600 x 300 dpi  
Best mode: 600 x 600 dpi

## Software compatibility

MS Windows compatible (3.1x, 95, 98, and NT 4.0)  
DOS application support through Windows 3.1x, 95, 98 only

## Duty cycle

1,000 pages per month

## Buttons/Lights

Resume, Power, Banner, and Print Cartridge light

## I/O Interface

Centronics parallel, IEEE 1284 compliant with 1284-B receptacle

## Dimensions

17.5 in wide x 7.3 in high x 14 in deep  
446 mm wide x 185 mm high x 355 mm deep

## Weight

12 lbs, 5.5 kg

## Recommended media weight

Paper: 16 to 110 lb index  
60 to 200 g/m<sup>2</sup>  
Envelopes: 20 to 24 lb  
75 to 90 g/m<sup>2</sup>  
Cards: 110 lb index max; 0.012 in max thickness  
110 to 200 g/m<sup>2</sup> 0.3 mm max thickness  
Banner Paper: 20 lb, 75 g/m<sup>2</sup>

\* Approximate figures. Exact speed will vary depending on the system configuration, software program, and document complexity.

\*\* Measured in addressable raster points per inch. 300 DPI multi-level data enhanced with C-RET to selected resolution.

## Media size

Custom size:	Width:	3.0 to 8.5 in 77 to 215 mm
	Length:	3 to 14 in 77 to 356 mm
U.S. letter		8.5 x 11 in
Banner U.S. letter		8.5 x 11 in
U.S. legal		8.5 x 14 in
Executive		7.25 x 10.5 in
U.S. No. 10 envelope		4.13 x 9.5 in
Invitation A2 envelope		4.37 x 5.75 in
Index card		3 x 5 in 77 x 127 mm
Index card		4 x 6 in 102 x 152 mm
Index card		5 x 8 in 127 x 203 mm
European A4		210 x 297 mm
European A5		148 x 210 mm
Banner European A4		210 x 297 mm
B5-JIS		182 x 257 mm
European DL envelope		220 x 110 mm
European C6 envelope		114 x 162 mm
European A6 card		105 x 148 mm
Japanese Hagaki postcard		100 x 148 mm

## Media handling

Sheets:	up to 100 sheets
Banners:	up to 20 sheets
Envelopes:	up to 15 envelopes
Cards:	up to 30 cards
Transparencies:	up to 25 sheets
Labels:	up to 20 sheets of Avery paper labels. Use only U.S. letter-sized or A4-sized sheets. Use only Avery paper labels specifically designed for use with HP inkjet printers.
OUT tray capacity:	up to 50 sheets

## Power requirements

Power Adapter (universal input)	
Input Voltage:	100 to 240 VAC (±10%)
Input Frequency:	50 to 60 Hz (±3 Hz)
Automatically accommodates the world-wide range of AC line voltages and frequencies. There is no on/off switch on the power adapter.	

## Power consumption

5 watts maximum when off
5 watts maximum nonprinting
30 watts maximum printing

## Operating environment

Maximum operating temperature:	41°F to 104°F, 5°C to 40°C
Humidity:	15 to 80% RH noncondensing
Recommended operating conditions for best print quality:	59°F to 95°F or 15°C to 35°C
	20 to 80% RH noncondensing
Storage temperature:	-40°F to 140°F, -40°C to 60°C

Declared noise emissions in accordance with ISO 9296:

	Normal Mode
Sound power level, $L_{WA,d}$ (1B=10dB):	5.5 B
Sound pressure level, $L_{pA,m}$ (bystander positions):	42 dB

# Additional symbol sets and fonts

Additional symbol sets and fonts may have been included with your printer on separate DOS Character Set Installation disks.

## Installing a special symbol set or font on your computer

- 1 Install the printer software as described in the setup guide.
- 2 Put the first installation disk into your computer's floppy disk drive.
- 3 If you are running Windows 95 or Windows 98, click *Start*, and then click *Run*. If you're running Windows 3.x, in the Program Manager, click *File*, and then click *Run*.
- 4 Type the letter of the computer's floppy disk drive (usually A:\ or B:\) followed by PCLSETUP and press the ENTER key. For example:  
**C:\>A:\PCLSETUP**
- 5 Follow the directions on the computer screen.
- 6 Remove the last installation disk from the floppy drive when the installation is completed.

## Available symbol sets and fonts

See the appropriate language option in the following list.

### Hebrew

Symbol Sets:	Latin/Hebrew (ISO-8859/8) PC Hebrew (CP-862)
--------------	---

### Fonts:

Proportional Spaced	Point Sizes	
David PS	5, 6, 7, 8, 10, 12, 14	
NarkisTam	5, 6, 7, 8, 10, 12, 14	
Miriam PS	5, 6, 7, 8, 10, 12, 14	
Miriam PS Italic	5, 6, 10, 12	
Fixed Space	Point Sizes	Pitches
Courier	6, 12, 24	5, 10, 16.67, 20
Courier Italic	6, 12, 24	5, 10, 20
Miriam	6, 12, 24	6, 12, 24
Miriam Italic	6, 12, 24	6, 12, 24
David	6, 12, 24	5, 10, 16.67, 20

## Arabic

Symbol Sets: HP Arabic-8  
PC Arabic (CP-864)

Fonts:		Point Sizes	Pitches
Proportional Spaced		5, 6, 7, 8, 10, 12, 14	12, 10
Ryadh			
Fixed Space		Point Sizes	Pitches
Naskh		6, 12, 24	5, 10, 20
Naskh		7, 14, 28	8.5, 17
Koufi		6, 12, 24	6, 12, 24

## Cyrillic

Symbol Sets: PC-Cyrillic (CP-866)  
Latin Cyrillic (ISO-8859/5)

Fonts:		Point Sizes	Pitches
Proportional Spaced		5, 6, 7, 8, 10, 12, 14	
CG Times			
CG Times Italic		5, 6, 7, 8, 10, 12, 14	
Univers		5, 6, 7, 8, 10, 12, 14	
Univers Italic		5, 6, 10, 12	
Fixed Space		Point Sizes	Pitches
Courier		6, 12, 24	5, 10, 16.67, 20
Courier Italic		6, 12, 24	5, 10, 20
Letter Gothic		6, 12, 24	6, 12, 24
Letter Gothic Italic		6, 12, 24	6, 12, 24

## Greek

Symbol Sets: PC-8 Greek (CP-866)  
Latin/Greek (ISO-8859/7)

Fonts:		Point Sizes	Pitches
Proportional Spaced		5, 6, 7, 8, 10, 12, 14	
CG Times			
CG Times Italic		5, 6, 7, 8, 10, 12, 14	
Univers		5, 6, 7, 8, 10, 12, 14	
Univers Italic		5, 6, 10, 12	
Fixed Space		Point Sizes	Pitches
Courier		6, 12, 24	5, 10, 16.67, 20
Courier Italic		6, 12, 24	5, 10, 20
Letter Gothic		6, 12, 24	6, 12, 24
Letter Gothic Italic		6, 12, 24	6, 12, 24

## Baltic

Symbol Sets: PC Latvian/Russian  
PC Lithuanian/Russian  
PC Lithuanian CP-772

Fonts:		Point Sizes	Pitches
Proportional Spaced		5, 6, 7, 8, 10, 12, 14	
CG Times			
CG Times Italic		5, 6, 7, 8, 10, 12, 14	
Univers		5, 6, 7, 8, 10, 12, 14	
Univers Italic		5, 6, 10, 12	
Fixed Space		Point Sizes	Pitches
Courier		6, 12, 24	5, 10, 16.67, 20
Courier Italic		6, 12, 24	5, 10, 20
Letter Gothic		6, 12, 24	6, 12, 24
Letter Gothic Italic		6, 12, 24	6, 12, 24

## Thai

Symbol Sets: TIS (TAPIC23)

Fonts:		Point Sizes	Pitches
Fixed Space		12	10
Thai Courier, Courier Bold, Courier Italic, and Bold Italic			
Thai Courier, Courier Bold, and Courier Italic		10	12
Thai Courier, Courier Bold, and Courier Italic		24	6
Thai Line Printer		8.5	16



# Ordering supplies and accessories

Parts/ Supplies/Accessories	HP Reorder Number
<b>HP IEEE-1284-Compliant Parallel Interface Cable</b> (with one 1284-A connector for the computer port and one 1284-B connector for the printer port)	
2-meter length	C2950A
3-meter length	C2951A
<b>Power Adapter (worldwide)</b>	C6409-60014
<b>Power Cords</b>	
U.S., Canada, Brazil, Latin America, Saudi Arabia	8120-8330
Japan	8120-8336
U.K., Singapore, Malaysia	8120-8341
Middle East, Hong Kong	
South Africa	8120-8347
India	8120-8345
Australia, Argentina	8120-8337
China, Taiwan, Philippines	8120-8346
Korea	8120-8339
Europe, Jordan, Lebanon, North Africa, Israel, Russia, Baltic countries, Thailand, Indonesia, Caribbean, Latin America	8120-8340
<b>Print Cartridge</b>	
Black print cartridge	51645A or 51645G
Color print cartridge	C1823A

Parts/ Supplies/Accessories	HP Reorder Number
<b>Paper *</b>	
<i>HP Banner Paper</i>	
U.S. letter, 100 sheets	C1820A
210 x 297 mm, 100 sheets	C1821A
<i>HP Premium Inkjet Transparency Film</i>	
U.S. letter, 50 sheets	C3834A
U.S. letter, 20 sheets	C3828A
European A4, 50 sheets	C3835A
European A4, 20 sheets	C3832A
<i>HP Premium Inkjet Rapid-Dry Transparencies</i>	
U.S. letter, 50 transparencies	C6051A
European A4, 50 transparencies	C6053A
<i>HP Premium Heavyweight Inkjet Paper</i>	
U.S. letter, 100 sheets	C1852A
European A4, 100 sheets	C1853A
<i>HP Premium Inkjet Paper</i>	
U.S. letter, 200 sheets	51634Y
European A4, 200 sheets	51634Z
<i>HP Greeting Card Paper</i>	
Prescored for quarter fold	
U.S. letter, 20 sheets, 20 envelopes	C1812A
European A4, 20 sheets, 20 envelopes	C6042A
<i>HP Glossy Greeting Card Paper</i>	
Prescored for half fold	
U.S. letter, 10 sheets, 10 envelopes	C6044A
European, 10 sheets, 10 envelopes	C6045A
<i>HP Deluxe Photo Paper</i>	
U.S. letter, 20 sheets	C6055A
European A4, 20 sheets	C6057A
<i>HP Premium Photo Paper</i>	
U.S. letter, 15 sheets	C6039A
Asian A4, 15 sheets	C6043A
European A4, 15 sheets	C6040A
<i>HP Photo Paper</i>	
U.S. letter, 20 sheets	C1846A
Asian A4, 20 sheets	C6765A
European A4, 20 sheets	C1847A
<i>HP Bright White Inkjet Paper</i>	
U.S. letter, 500 sheets	C1824A
U.S. letter, 200 sheets	C5976A
European A4, 500 sheets	C1825A
European A4, 200 sheets	C5977A
<b>Transfer Media *</b>	
HP Iron-On T-Shirt Transfers	
U.S. letter, 10 sheets	C6049A
Asian A4, 10 sheets	C6065A
European A4, 10 sheets	C6050A

\* Availability of special media varies by country.

<b>Replaceable Parts</b>	<b>HP Reorder Number</b>
<b>HP DeskJet 710C Series</b>	<b>Manual</b>
<b>Printer Documentation Kits</b>	<b>Kits</b>
Arabic	C5894-60014
Czech	C5894-60015
Danish	C5894-60016
Dutch	C5894-60017
English	C5894-60003
Finnish	C5894-60018
French	C5894-60004
German	C5894-60019
Greek	C5894-60020
Hebrew	C5894-60021
Hungarian	C5894-60022
Italian	C5894-60023
Japanese	C5894-60005
Korean	C5894-60024
Norwegian	C5894-60025
Polish	C5894-60026
Portuguese	C5894-60006
Russian	C5894-60027
Simplified Chinese	C5894-60028
Spanish	C5894-60007
Swedish	C5894-60029
Thai	C5894-60031
Traditional Chinese	C5894-60030
Turkish	C5894-60032
<b>Top Cover (Access Door Assembly)</b>	<b>C4557-40052</b>
<b>Cable Access Door (I/O Cover)</b>	<b>C4557-40101</b>
<b>Rear Access Door Assembly</b>	<b>C4557-60076</b>

# Ordering information

To order printer supplies or accessories, call your nearest HP dealer or call HP DIRECT at the following numbers for fast shipping service:

- **Argentina:** (54 1) 787-7100  
Fax: (54 1) 787-7213  
Hewlett-Packard Argentina, Montañeses 2150  
1428 Buenos Aires, Argentina
- **Australia/New Zealand:** (03) 895-2895  
China Resources Bldg.  
26 Harbour Road  
Wanchai, Hong Kong
- **Austria-South-East Area:** (43-0222) 25 000, ext. 755  
Fax: (43-0222) 25 000, ext. 610  
Hewlett-Packard Ges.m.b.H.  
Ersatzteilverkauf, Lieblg. 1  
A-1222 Wien
- **Belgium:** 02/778 3092 (or 3090, 3091)  
Fax: 02/778 3076  
Hewlett-Packard Belgium SA/NV  
100 bd. de la Woluwe/Woluwedal  
1200 BRUXELLES
- **Brazil:** 55-11-7296-4991  
Fax: 55-11-7296-4967  
Edisa Hewlett-Packard SA, R. Aruana 125, Tambore, Barueri, São Paulo,  
Brazil, 06460-010
- **Canada:** (800) 387-3154, (905) 206-4725  
Fax: (905) 206-3485/-3739  
Hewlett-Packard (Canada) Ltd., 5150 Spectrum Way  
Mississauga, Ontario L4W 5G1  
**Toronto:** (416) 671-8383
- **Chile:** (56 2) 203-3233  
Fax: (56 2) 203-3234  
Hewlett-Packard de Chile SA  
Av. Andres Bello 2777, Oficina 1302  
Los Condes, Santiago, Chile
- **Denmark:** 45 99 14 29  
Fax: 42 81 58 10  
Hewlett-Packard A/S  
Kongevejen 25, 3460 BIRKEROD
- **Finland:** (90) 8872 2397  
Fax: (90) 8872 2620  
Hewlett-Packard Oy  
Varaosaamynti, Piispankalliontie 17  
02200 ESPOO
- **France:** (1) 40 85 71 12  
Fax: (1) 47 98 26 08  
EuroParts, 77 101 avenue du Vieux Chemin de Saint-Denis  
92625 GENNEVILLIERS
- **Germany:** 07031-145444  
Fax: 07031-141395  
Hewlett-Packard GmbH, HP Express Support  
Ersatzteil-Verkauf, Herrenberger Str. 130  
71034 BOEBLINGEN
- **International Sales Branch:** (41) 22 780 4111  
Fax: (41) 22 780-4770  
Hewlett-Packard S. A., ISB  
39, rue de Veyrot  
1217 MEYRIN 1, GENEVE - SUISSE
- **Italy:** 02/9212.2336/2475  
Fax: 02/92101757  
Hewlett-Packard Italiana S. P. A.  
Ufficio Parti di ricambio  
Via G. Di Vittorio, 9  
20063 Cernusco s/N (MI)
- **Japan:** (03) 3335-8333  
Hewlett-Packard Japan Ltd.  
29-21 Takaido-Higashi 3-chone, suginami-ku  
Tokyo 168-8585
- **Latin America Headquarters:** (305) 267-4220  
Fax: (305) 267-4247  
5200 Blue Lagoon Drive, Suite 950  
Miami, FL 33126
- **Mexico:** (52 5) 258-4600  
Fax: (54 1) 258-4362  
Hewlett-Packard de México, S.A. de C.V  
Prolongación Reforma +700  
Colonia Lomas de Santa Fe, C.P. 01210 México, D.F.
- **Netherlands:** 0 33 450 1808  
Fax: 0 33 456 0891  
Hewlett-Packard Nederland B. V., Parts Direct Service  
Basicweg 10  
3821 BR AMERSFOORT
- **Norway:** 22735926  
Fax: 22735611  
Hewlett-Packard Norge A/S, Express Support  
Drammensveien 169-171  
0212 Oslo
- **Spain:** 1 6 31 14 81  
Fax: 1 6 31 12 74  
Hewlett-Packard Espanola S.A.  
Departamento de Venta de Piezas  
Ctra N-VI, Km. 16,500  
28230 LAS ROZAS, Madrid
- **Sweden:** 8-4442239  
Fax: 8-4442116  
Hewlett-Packard Sverige AB  
Skalholtsgatan 9, Box 19  
164 93 KISTA
- **Switzerland:** 056/279 286  
Fax: 056/279 280  
Elbatex Datentechnik AG  
Schwimmbastrasse 45, 5430 WETTINGEN
- **United Kingdom:**  
+44 1765 690061, Fax: +44 1765 690731  
Express Terminals, 47 Allhallowgate  
Ripon, North Yorkshire  
+44 181 568 7100, Fax: +44 181 568 7044  
Parts First, Riverside Works  
Isleworth, Middlesex, TW7 7BY  
+44 1734 521587, Fax: +44 1734 521712  
Westcoast, 28-30 Richfield Avenue  
Reading, Berkshire, RG1 8BJ
- **United States:** (800) 227-8164
- **Venezuela:** (58 2) 239-4244/4133  
Fax: (58 2) 207-8014  
Hewlett-Packard de Venezuela C.A.  
Tercera Transversal de Los Ruices Norte, Edificio  
Segre, Caracas 1071, Venezuela  
Apartado Postal 50933, Caracas 1050

## Elsewhere in the world

- **Hewlett-Packard Company,**  
Intercontinental Headquarters,  
3495 Deer Creek Road,  
Palo Alto, CA 94304, U.S.A.

# Regulatory Notices

## FCC statement (USA)

The United States Federal Communications Commission (in 47 CFR 15.105) has specified that the following notice be brought to the attention of users of this product:

This equipment has been tested and found to comply with the limits for a Class B digital device, pursuant to part 15 of the FCC Rules. These limits are designed to provide reasonable protection against harmful interference in a residential installation. This equipment generates, uses, and can radiate radio frequency energy and, if not installed and used in accordance with the instructions, may cause harmful interference to radio communications. However, there is no guarantee that interference will not occur in a particular installation. If this equipment does cause harmful interference to radio or television reception, which can be determined by turning the equipment off and on, the user is encouraged to try to correct the interference's by one or more of the following measures:

- Reorient or relocate the receiving antenna.
- Increase the separation between the equipment and the receiver.
- Connect the equipment into an outlet on a circuit different from that to which the receiver is connected.
- Consult the dealer or an experienced radio/TV technician for help.

Use of a shielded cable is required to comply within Class B limits of Part 15 of FCC Rules.

Pursuant to Part 15.21 of the FCC Rules, any changes or modifications to this equipment not expressly approved by Hewlett-Packard Company may cause harmful interference and void the FCC authorization to operate this equipment.

## LED Indicator Statement

The display LEDs meet the requirements of EN 60825-1.

## Power Module Statement

The power module cannot be repaired. If it is defective it should be discarded or returned to the supplier.

この装置は、情報処理装置等電波障害自主規制協議会（VCCI）の基準に基づくクラスB情報技術装置です。この装置は、家庭環境で使用することを目的としていますが、この装置がラジオやテレビジョン受信機に近接して使用されると受信障害を引き起こすことがあります。  
取り扱い説明書に従って正しい取り扱いをして下さい。

### 사용시 안내문 (A급 기기)

이 기기는 업무용으로 전자파장애검정을 받은 기기이오니, 만약 잘못 구입하셨을 때에는 구입한 곳에서 비업무용으로 교환하시기 바랍니다.

### 사용자 안내문 (B급 기기)

이 기기는 비업무용으로 전자파장애검정을 받은 기기로서, 주거지역에서는 물론 모든 지역에서 사용할 수 있습니다.

# Limited Warranty Statement

## HP Product

## Duration of Limited Warranty

Software	90 Days
Print cartridges	90 Days
Printer	1 Year

### A. Extent of Limited Warranty

1. Hewlett-Packard (HP) warrants to the end-user customer that the HP products specified above will be free from defects in materials and workmanship for the duration specified above, which duration begins on the date of purchase by the customer. Customer is responsible for maintaining proof of date of purchase.
2. For software products, HP's limited warranty applies only to a failure to execute programming instructions. HP does not warrant that the operation of any product will be uninterrupted or error free.
3. HP's limited warranty covers only those defects which arise as a result of normal use of the product, and do not apply to any:
  - a. Improper or inadequate maintenance or modification;
  - b. Software, interfacing, media, parts, or supplies not provided or supported by HP; or
  - c. Operation outside the product's specifications.
4. For HP printer products, the use of a non-HP ink cartridge or a refilled ink cartridge does not affect either the warranty to the customer or any HP support contract with the customer. However, if printer failure or damage is attributable to the use of a non-HP or refilled ink cartridge, HP will charge its standard time and materials charges to service the printer for the particular failure or damage.
5. If HP receives, during the applicable warranty period, notice of a defect in any software, media, or ink cartridge product which is covered by HP's warranty, HP shall replace the defective product. If HP receives, during the applicable warranty period, notice of a defect in any hardware product which is covered by HP's warranty, HP shall either repair or replace the defective product, at HP's option.
6. If HP is unable to repair or replace, as applicable, a defective product which is covered by HP's warranty, HP shall, within a reasonable time after being notified of the defect, refund the purchase price for the product.
7. HP shall have no obligation to repair, replace, or refund until the customer returns the defective product to HP.
8. Any replacement product may be either new or like-new, provided that it has functionality at least equal to that of the product being replaced.
9. HP's limited warranty is valid in any country where the covered HP product is distributed by HP except for the Middle-East, Africa, Argentina, Brazil, Mexico, Venezuela, and France's "Departments d'Outre-Mer"; for those excepted areas, the warranty is valid only in the country of purchase. Contracts for additional warranty services, such as on-site service, may be available from any authorized HP service facility in countries where the product is distributed by HP or by an authorized importer.

### B. Limitations of Warranty

1. TO THE EXTENT ALLOWED BY LOCAL LAW, NEITHER HP NOR ITS THIRD PARTY SUPPLIERS MAKE ANY OTHER WARRANTY OR CONDITION OF ANY KIND, WHETHER EXPRESS OR IMPLIED, WITH RESPECT TO THE HP PRODUCTS, AND SPECIFICALLY DISCLAIM THE IMPLIED WARRANTIES OR CONDITIONS OF MERCHANTABILITY, SATISFACTORY QUALITY, AND FITNESS FOR A PARTICULAR PURPOSE.

### C. Limitations of Liability

1. To the extent allowed by local law, the remedies provided in this Warranty Statement are the customer's sole and exclusive remedies.
2. TO THE EXTENT ALLOWED BY LOCAL LAW, EXCEPT FOR THE OBLIGATIONS SPECIFICALLY SET FORTH IN THIS WARRANTY STATEMENT, IN NO EVENT SHALL HP OR ITS THIRD PARTY SUPPLIERS BE LIABLE FOR DIRECT, INDIRECT, SPECIAL, INCIDENTAL, OR CONSEQUENTIAL DAMAGES, WHETHER BASED ON CONTRACT, TORT, OR ANY OTHER LEGAL THEORY AND WHETHER ADVISED OF THE POSSIBILITY OF SUCH DAMAGES.

### D. Local Law

1. This Warranty Statement gives the customer specific legal rights. The customer may also have other rights which vary from state to state in the United States, from province to province in Canada, and from country to country elsewhere in the world.
2. To the extent that this Warranty Statement is inconsistent with local law, this Warranty Statement shall be deemed modified to be consistent with such local law. Under such local law, certain disclaimers and limitations of this Warranty Statement may not apply to the customer. For example, some states in the United States, as well as some governments outside the United States (including provinces in Canada), may:
  - a. Preclude the disclaimers and limitations in this Warranty Statement from limiting the statutory rights of a consumer (e.g., the United Kingdom);
  - b. Otherwise restrict the ability of a manufacturer to enforce such disclaimers or limitations; or
  - c. Grant the customer additional warranty rights, specify the duration of implied warranties which the manufacturer cannot disclaim, or not allow limitations on the duration of implied warranties.
3. FOR CONSUMER TRANSACTIONS IN AUSTRALIA AND NEW ZEALAND, THE TERMS IN THIS WARRANTY STATEMENT, EXCEPT TO THE EXTENT LAWFULLY PERMITTED, DO NOT EXCLUDE, RESTRICT, OR MODIFY, AND ARE IN ADDITION TO, THE MANDATORY STATUTORY RIGHTS APPLICABLE TO THE SALE OF HP PRODUCTS TO SUCH CUSTOMERS.

# Index

## Symbols

- (Black cartridge) 49
- ⏻ (Power button) 42, 44
- ☒ (Print cartridge light) 44, 50
- ⏮ (Resume button) 6, 38, 44
- (Tri-Color cartridge) 49, 50

## A

- accessories, ordering 60
- addresses for ordering 62
- adjusters, paper 3, 4
- aligning print cartridges 10, 42
- America Online 45
- art, printing 21–22
- Avery labels 29, 30, 58

## B

- Banner light 36
- banner switch 36, 43
- banners
  - choosing paper for 36, 58
  - loading problems 43
  - margin problems 43
  - paper jams 37, 43
  - paper types to avoid 36
  - preparing paper for 37
  - print settings 36
  - printing 36–38
  - problems 38, 43
- Best mode print speed 57
- Best print quality 10
- bidirectional communications 7, 43, 44, 48
- black and white printing 10
- black print speed 57

- black resolution 57
- bleeding ink 3, 43
- Book option 16
- brightness of paper 2
- business cards 34
- business forms 14
- button
  - Power 42
  - Resume 6, 38

## C

- cable 44
- capacity of paper 3
- cards
  - choosing paper for 34, 58
  - orientation 34
  - print settings 34
  - printing 34–35
  - stacking 34
- cartridges *See print cartridges*
- CD-ROM disk 22
- charts 2
- choosing paper 2, 43
- cleaning print cartridges 10, 43
- clearing jammed paper 6
- clip art 21
- coated paper 2
- color
  - about 19
  - adjusting 20
  - matching 19
  - missing 43
  - options 20
  - paper choices 2
  - printing 2
  - problems 19, 43
  - turning off 19
  - wrong 43

- color print speed 57
- color resolution 57
- ColorSmart technology 20
- communications 44
  - bidirectional 42, 43, 48
  - printer 44
  - problems 7
  - two-way 42, 43
- CompuServe 45
- copyright law 21
- custom paper sizes 14
- customer support 45
- Cut-Sheet option 38

## D

- default print settings 5
- default printer 42
- dialog boxes *See HP print settings box and HP Toolbox*
- different paper size 14
- digital photographs 22
- door
  - rear access 6
  - top cover 61
- DOS
  - printing 48, 56
  - system requirements 48
- DOS Character Set 58
- double-sided printing *See two-sided printing*
- dpi, in pictures 22
- draft mode 10
- drawer
  - IN 3, 4, 58
  - paper 58
- driver
  - printer software 45
- duty cycle 57

## E

- EconoFast mode
  - print speed 57
  - when to use 10, 43
- electronic files, creating 21–22
- electronic support 45
- energy usage 18, 58
- envelopes
  - choosing 26, 58
  - creating 28
  - multiple 27
  - print settings 26, 27
  - printing 26–28
  - problems with 27
  - rotating 27
  - single-envelope slot 26
  - sizes 27
  - types to avoid 26
- environment, operating 48, 58
- error messages 7

## F

- FAQs 45
- faxes 42
- fibers on cartridges 52
- files, electronic 21–22
- Flip Horizontal
  - iron-on transfers 39
  - print setting 18
- flipped printing 18
- fonts 23
  - buying 24
  - choosing 23
  - installing additional 58
  - previewing 24
  - sans serif 23
  - serif 23
  - special-purpose 23
  - TrueType 24
  - Type1 24
  - using 24
- forms, multi-part 3
- fuzzy printing 38

## G

- glossy paper 2
- grayscale

- drafts 19
  - inadvertent use of 43
  - printing 10
  - turning on and off 19
- greeting cards 35

## H

- help
  - HP Toolbox 11
  - online 40
  - technical support 45
- Hewlett-Packard papers 2
  - ordering from HP 60
- How Do I? tab (HP Toolbox) 12
- HP Banner Paper 36
- HP Bright White Inkjet Paper 2
- HP Custome Care Web site 45
- HP Deluxe Photo Paper 2, 5, 33
- HP DeskJet Utilities 11
- HP Direct 2
- HP Greeting Card Paper 35
- HP Inkjet print cartridges *See print cartridges*
- HP Premium Inkjet Paper 2
- HP Premium Transparency Film 31
- HP print settings box 8
  - finding 9
  - purpose of 10
  - See also print settings*
- HP Special Paper setting 5
- HP Toolbox
  - about 8, 12
  - finding 11

## I

- IN drawer
  - capacity of 3, 58
  - use of 4
- index cards 34
- ink
  - bleeding 3, 43
  - controlling amount 43
  - misaligned colors 42
  - non-HP 49
  - refilling cartridges 49
  - repelled 3
  - smearing 17, 43

- ink streaks 52
- Internet
  - accessing HP Customer Care Web site 45
- invoices 14
- iron-on transfers
  - printing 39
  - uses for 39

## J

- jams *See paper jams*

## K

- Kodak Image Enhancements 33

## L

- labels
  - choosing types to use 29, 58
  - formatting for 30
  - loading sheets 30
  - print settings 29
  - printing 29–30
  - types to avoid 29
- landscape orientation 42
- lights
  - Banner 36
  - Power 42, 44
  - Print Cartridge 41, 44
  - Resume 6, 38, 44
- loading paper
  - after running out 6
  - banner paper 36–38
  - basic instructions 3–4
  - card stock 34–35
  - envelopes 26–28
  - iron-on transfer paper 39
  - label sheets 29–30
  - photo paper 33
  - transparencies 31–32

## M

- manuals, ordering 61
- margins 42, 43
  - banners 43
  - minimum printing 57
  - paper size 42

- printable area 4
- problems 42, 43
- matching colors 19
- media size 58
- media weight, recommended 57
- messages, error 7
- Microsoft Windows 3.1 48
- Microsoft Windows 95 48
- Microsoft Windows NT 4.0 48
- Milestones font 23
- mirrored printing 18
- missing lines 51
- modes, printing
  - Best 57
  - draft 10
  - EconoFast 43, 57
  - Normal 57
  - printing speeds 57
  - See also print quality*
- MS-DOS *See DOS*
- multi-part forms 3
- multiple copies 9–10
- multiple envelopes 27

## N

- networking 48
- Normal mode print speed 57

## O

- online troubleshooting 40
- online user forums 45
- opacity of paper 2
- operating environment 48, 58
- Options, color *See also print settings*
- ordering
  - addresses for 62
  - manuals 61
  - supplies and accessories 60
- orientation, paper 42
- origami 15
- Out of Paper message 6
- OUT tray 3, 58

## P

- paper
  - brightness of 2

- choosing 2, 43
- coated 2
- condition of 3
- for inkjet printers 3
- for photocopies 2
- for photographs 2
- for pictures 2
- Hewlett-Packard 2
- loading 3–4
- opacity of 2
- orientation 42
- preprinted 14
- printsides 4
- See also banners, cards, iron-on transfers, labels*
- specifications 57–58
- textured 3
- two-sided printing 2, 16
- types to avoid 3
- types to use 2
- weight of 2, 57
- paper adjusters 3, 4
- paper drawer capacity 3, 58
- paper jams
  - banners 37, 43
  - can't find paper 6
  - due to poor paper condition 3
  - recovering from 6
- paper size
  - custom 14
  - different 14
  - setting 10
  - size options 2, 57
- paper type
  - HP Deluxe Photo Paper 5
  - HP Special Paper 5
  - Plain Paper 5
- Paper Type setting 10
- paper-length adjuster 3
- paper-width adjuster 3
- photographs
  - digital 22
  - paper for 2, 33
  - printing speed 42
- pictures
  - as computer files 21–22
  - drawing 21
  - paper for 2
  - printing speed 42
  - scanning 21

- sources for 21
- Plain Paper setting 5
- portrait orientation 42
- postcards 34
- power adapter
  - purchasing 60
- power consumption 18, 58
- power cord 60
- Power light 42
- power requirements 58
- preferences *See HP print settings box*
- preprinted paper 14
- print cartridges
  - aligning 10, 42, 50
  - cleaning 10, 43, 51
  - light 41
  - problems with 6, 41, 42
  - purchasing 60
  - refilling 49
  - removing 50
  - replacing 43
- Print in Grayscale setting 19
- print margins 4, 57
- print quality
  - and refilled cartridges 49
  - Best 10
  - EconoFast 10
  - problems 43, 49
  - transparencies 31
- print settings 5
  - banners 5, 36
  - cards 5, 34
  - default 5
  - envelopes 26
  - Flip Horizontal 18
  - iron-on transfers 5
  - labels 29
  - photographs 5, 33
  - transparencies 31
  - two-sided printing 9–10, 16
- print settings box *See HP print settings box*
- print speed
  - black 57
  - color 57
  - photographs 42
  - pictures 42
  - specifications 57
- print technology 57



printer  
  cable for 44  
  communications 7, 44  
  default 42  
  IN drawer 4  
  loading paper 3–4  
  OUT tray 3  
  paper capacity 3  
  paper drawer 58  
  specifications 57  
printer drivers 55  
Printer Services tab (HP Toolbox) 12  
printer software 8, 45  
printing  
  basic instructions 5–7  
  basic problems 6–7  
  drafts 10  
  flipped 18  
  from DOS 48, 56  
  mirrored 18  
  two-sided 16  
printing grayscale 10  
printside of paper 4

**Q**  
quality *See print quality*

**R**  
rear access door 6  
recipe cards 34  
refilling cartridges 49  
regulatory notices 63  
replacing print cartridges 43  
requirements, system 48  
resolution 57  
Resume button 6, 38

**S**  
scanning pictures 21  
serif fonts 23  
settings, print *See print settings*  
single envelopes 26  
single-envelope slot 26  
size  
  media 58  
  paper 2

  specifications 57  
  smeared ink 17, 43  
  smoothness of paper 2  
  software  
    printer 8, 45  
  software compatibility 48, 57  
  special-purpose fonts 23  
  specifications 57–58  
  speed, printing 42, 57  
  spotchy printouts 6, 43  
  statements, business 14  
  streaking ink 54  
  stuck paper *See paper jams*  
  supplies and accessories  
    ordering 60  
  support  
    customer 45  
  switch, banner 36, 43  
  symbol sets 58  
    available 58  
  system requirements 48

**T**  
Tablet option 16  
taskbar, Windows 11  
technical support 45  
testing printer cable 44  
text, about 23  
textured paper 2, 3  
Toolbox *See HP Toolbox*  
transfers, iron-on 39  
transparencies  
  adhesive strip 32  
  choosing types to use 31  
  print quality 31  
  print settings 31  
  printing 31–32  
  problems 32  
  writing on 32  
tray, OUT 58  
troubleshooting 40–46  
  banners 37, 43  
  communications 7  
  during printing 6  
  envelopes 27  
  general instructions for 7, 40  
  margins 42, 43  
  misaligned inks 42

  online 40  
  paper ejection 6  
  paper types to avoid 3  
  poor print quality 49  
  print cartridges 6, 42, 43  
  *See also paper jams*  
  spotchy 6  
  Windows NT 4.0 48  
Troubleshooting tab (HP  
  Toolbox) 12  
TrueType fonts 24  
t-shirts, iron-on transfers 39  
two-sided printing 9–10, 16  
  paper for 2  
  problems 16, 17  
two-way communications 7, 43, 44  
Type 1 fonts 24  
types of paper 2

**U**  
uneven printing printouts 6  
uninstalling software  
  Windows 3.1x 55  
  Windows 95 55  
  Windows 98 55  
  Windows NT 4.0 55  
user forums, online 45

**W**  
warranty statement 64  
Web site, HP Customer Care 45  
weight  
  paper 2, 57  
  recommended media 57  
window envelopes 26  
Windows 3.1x 9  
Windows 3.1x 48  
Windows 95 9, 48  
Windows 98 48  
Windows NT 4.0 9, 48  
  current options 48  
Windows taskbar 11  
Wingdings font 23  
WWW support 45

# Reduce, Reuse, Recycle

## Protecting the Environment

Hewlett-Packard continuously improves the design and production processes of HP DeskJet and DeskWriter printers to minimize the negative impact on the office environment and on the communities where the printers are manufactured, shipped, and used. Hewlett-Packard has also developed processes to minimize the negative impact of the disposal of the printers at the end of printing life.

## Reduction and Elimination

**Printer Packaging:** Packaging materials, cushions, accessories, and boxes have been reduced, saving roughly 50% in fuel and, therefore, fuel emissions. Boxes used to ship printers from the distribution centers are whitened without using chlorine.

**Ozone:** All ozone-depleting chemicals (CFCs, for example) have been eliminated from Hewlett-Packard manufacturing processes.

## Recycling

**Printer Packaging:** The boxes used to ship printers from the distribution centers, the expanded polystyrene packaging inserts, and the clear polyethylene bags containing the printer drivers are 100% recyclable.

**Plastic Parts:** Major manufactured plastic parts are marked as to the plastic content to facilitate product recycling.

**Manuals:** The manuals in this kit are printed on recycled paper.

## Reduction and Reuse

**Ink Packaging:** The packaging for the ink cartridges was significantly reduced and made recyclable.

## Energy Consumption

HP DeskJet and DeskWriter printers use only 4.5 watts in stand-by mode, which easily qualifies them as energy-saving computer printers under the U.S. Environmental Protection Agency's Energy Star Computers program. The EPA estimates that if all desktop PCs and peripherals in the U.S. were to qualify, the overall savings in electricity could amount to over \$1 billion each year. It could also prevent the emission of 20 million tons of carbon dioxide per year (the equivalent output of 5 million cars).

The Energy Star emblem does not represent EPA endorsement of any product or service.

